

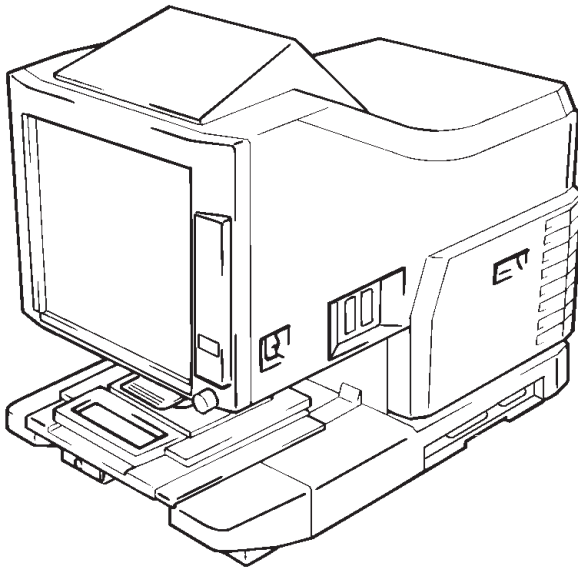

MS 6000

Operator's Manual



SAFETY INFORMATION



This section contains detailed instructions on the operation and maintenance of this machine. To achieve optimum utility of this device, all operators should carefully read and follow the instructions in this manual. Please keep this manual in a handy place near the machine.

Please read the next section before using this device. It contains important information related to user safety and preventing equipment problems.

Make sure you observe all of the precautions listed in this manual.

*Please note that some parts of the contents of this section may not correspond with the purchased product.

Warning and Precaution Symbols

 WARNING:	Ignoring this warning could cause serious injury or even death.
 CAUTION:	Ignoring this caution could cause injury or damage to property.

Meaning of Symbols



A triangle indicates a danger against which you should take precaution.



This symbol warns against cause burns.



A diagonal line indicates a prohibited course of action.



This symbol warns against dismantling the device.



A black circle indicates an imperative course of action.



This symbol indicates you must unplug the device.

WARNING



- Do not modify this product, as a fire, electrical shock, or breakdown could result. If the product employs a laser, the laser beam source could cause blindness.
- Do not attempt to remove the covers and panels which have been fixed to the product. Some products have a high-voltage part or a laser beam source inside that could cause an electrical shock or blindness.



- Only use the power cord supplied in the package. If a power cord is not supplied, only use the power cord and plug that is specified in POWER CORD INSTRUCTION. Failure to use this cord could result in a fire or electrical shock.
- Use only the specified power source voltage. Failure to do that could result in a fire or electrical shock.
- Do not use a multiple outlet adapter to connect any other appliances or machines. Use of a power outlet for more than the marked current value could result in a fire or electrical shock.



Do not unplug and plug in the power cord with a wet hand, as an electrical shock could result.



Plug the power cord all the way into the power outlet. Failure to do this could result in a fire or electrical shock.



- Do not scratch, abrade, place a heavy object on, heat, twist, bend, pull on, or damage the power cord. Use of a damaged power cord (exposed core wire, broken wire, etc.) could result in a fire or breakdown. Should any of these conditions be found, immediately turn OFF the power switch, unplug the power cord from the power outlet, and then call your authorized service representative.
- In principle, do not use an extension cord. Use of an extension cord could cause a fire or electrical shock. Contact your authorized service representative if an extension cord is required.



Do not place a flower vase or other container that contains water, or metal clips or other small metallic objects on this product. Spilled water or metallic objects dropped inside the product could result in a fire, electrical shock, or breakdown. Should a piece of metal, water, or any other similar foreign matter get inside the product, immediately turn OFF the power switch, unplug the power cord from the power outlet, and then call your authorized service representative.

WARNING



- If this product becomes inordinately hot or emits smoke, or unusual odor or noise, immediately turn OFF the power switch, unplug the power cord from the power outlet, and then call your authorized service representative. If you keep on using it as is, a fire or electrical shock could result.
- If this product has been dropped or its cover damaged, immediately turn OFF the power switch, unplug the power cord from the power outlet, and then call your authorized service representative. If you keep on using it as is, a fire or electrical shock could result.



Do not throw the toner cartridge or toner into an open flame. The hot toner may scatter and cause burns or other damage.



Connect the power cord to an electrical outlet that is equipped with a grounding terminal.

CAUTION



- Do not use flammable sprays, liquids, or gases near this product, as a fire could result.
- Do not leave a toner unit or drum unit in a place within easy reach of children. Licking or ingesting any of these things could injure your health.
- Do not let any object plug the ventilation holes of this product. Heat could accumulate inside the product, resulting in a fire or malfunction.
- Do not install this product at a site that is exposed to direct sunlight, or near an air conditioner or heating apparatus. The resultant temperature changes inside the product could cause a malfunction, fire, or electrical shock.
- Do not place the product in a dusty place, or a site exposed to soot or steam, near a kitchen table, bath, or a humidifier. A fire, electrical shock, or breakdown could result.
- Do not place this product on an unstable or tilted bench, or in a location subject to a lot of vibration and shock. It could drop or fall, causing personal injury or mechanical breakdown.
- After installing this product, mount it on a secure base. If the unit moves or falls, it may cause personal injury.
- Do not store toner units and PC drum units near a floppy disk or watch that are susceptible to magnetism. They could cause these products to malfunction.



The inside of this product has areas subject to high temperature, which may cause burns. When checking the inside of the unit for malfunctions such as a paper misfeed, do not touch the locations (around the fusing unit, etc.) which are indicated by a “CAUTION HOT” caution label.



Do not place any objects around the power plug as the power plug may be difficult to pull out when an emergency occurs.



The socket-outlet shall be installed near the machine and shall be easily accessible as the power plug may be difficult to pull out when an emergency occurs.

CAUTION



- Always use this product in a well ventilated location. Operating the product in a poorly ventilated room for an extended period of time could injure your health. Ventilate the room at regular intervals.
- Whenever moving this product, be sure to disconnect the power cord and other cables. Failure to do this could damage the cord or cable, resulting in a fire, electrical shock, or breakdown.
- When moving this product, always hold it by the locations specified in the operator's manual or other documents. If the unit falls it may cause severe personal injury. The product may also be damaged or malfunction.
- Remove the power plug from the outlet more than one time a year and clean the area between the plug terminals. Dust that accumulates between the plug terminals may cause a fire.
- When unplugging the power cord, be sure to hold onto the plug. Pulling on the power cord could damage the cord, resulting in a fire or electrical shock.

Precautions for Routine



- Do not store toner units, PC drum units, and other supplies and consumables in a place subject to direct sunlight and high temperature and humidity, as poor image quality and malfunction could result.
- Do not attempt to replace the toner unit and PC drum unit in a place exposed to direct sunlight. If the PC drum is exposed to intense light, poor image quality could result.
- Do not unpack a toner unit or PC drum unit until the very time of use. Do not leave an unpacked unit standing. Install it immediately or poor image quality could result.
- Do not keep toner units and PC drum units in an upright position or upside down, as poor image quality could result.
- Do not throw or drop a toner unit or PC drum unit as poor image quality could result.
- Do not use this product in an area where ammonia or other gases or chemicals are present. Failure to do so may shorten the service life of the product, cause damage or decrease performance.
- Do not use this product in an environment with a temperature outside the range specified in the operator's manual, as a breakdown or malfunction could result.
- Do not attempt to feed stapled paper, carbon paper or aluminum foil through this product, as a malfunction or fire could result.



Do not touch or scratch the surface of the toner unit developing roller and the PC drum, as poor image quality could result.



Use the supplies and consumables recommended by the dealer. Use of any supply or consumable not recommended could result in poor image quality and breakdown.

Welcome

Thank you for choosing Minolta quality. For over 30 years Minolta has been a leader on the forefront of office equipment technology and service. Our desire has always been to bring you highly reliable products. We pledge to continue to provide you, our customer with our state of the art equipment, as well as full customer service for all our products. We look forward to a long healthy relationship with you and our company. If you have any questions or comments about Minolta, our product or service, please let us know. Our fax number is 800-237-8087 (for U.S.A. and Canada). Thank you again.

This operator's manual explains how to operate the unit and replenish its supplies. It also gives some troubleshooting tips as well as general precautions to be observed when operating the unit.

To ensure the best performance and effective use of your unit, read this manual carefully until you familiarize yourself thoroughly with the unit's operation and features.

Please keep this manual and use it as a quick and handy reference tool for immediately clarifying any questions that may arise.

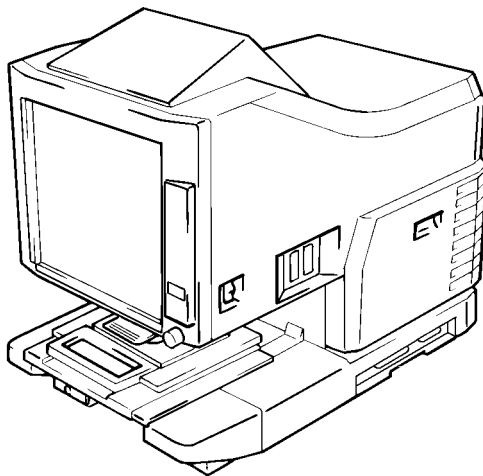

Please follow the instructions given in this manual when handling the system and do not touch any part of the system the manual does not cover.

NEVER attempt to disassemble or remodel the system.

The contents of this manual are subject to change without notice.

No part of this manual may be quoted, reproduced, or translated into any other language.

Notes to Operators and Key Operators

The following safety rules should be observed:

- [1] The unit should be kept free from moisture, dirt, dust and exposure to heat and direct sunlight at all times.
- [2] Keep hands, hair and clothing away from rollers and other moving parts.
- [3] Before removing the Projection Lamp Unit, confirm that the machine is turned "OFF".
- [4] Be sure that the proper voltage is used and that the machine is well grounded. The use of electrical extension cords is strongly discouraged.
- [5] For best performance, only authorized Minolta supplies are recommended for use with this unit. Failure to use authorized Minolta supplies may cause damage to the unit, in which case the warranty may be rendered void.
- [6] Do not attempt to remove any Cover that is secured.

WARNING

This equipment has been tested and found to comply with the limits for a Class A digital device, pursuant to Part 15 of the FCC Rules. These limits are designed to provide reasonable protection against harmful interference when the equipment is operated in a commercial environment. This equipment generates, uses, and can radiate radio frequency energy and, if not installed and used in accordance with the instruction manual, may cause harmful interference to radio communications. Operation of this equipment in a residential area is likely to cause harmful interference in which case the user will be required to correct the interference at his own expense.

The design and production of this unit conforms to FCC regulations, and any changes or modifications must be registered with the FCC and are subject to FCC control. Any changes made by the purchaser or user without first contacting the manufacturer will be subject to penalty under FCC regulations.

This Class A digital apparatus complies with Canadian ICES-003.

Cet appareil numérique de la classe A est conforme à la norme NMB-003 du Canada.

Safety Information (MSP 3000 Printer)

Laser Safety

This printer is a page printer which operates by means of a laser. There is no possibility of danger from the laser, provided the printer is operated according to the instructions provided in this manual.

Since radiation emitted by the laser is completely confined within protective housing, the laser beam cannot escape from the machine during any phase of user operation.

Internal Laser Radiation

Maximum Radiation Power: 8.8×10^{-4} (W)

Wave Length: 770-810 (nm)

This is a Class IIIb Laser Diode Assy. that has an invisible laser beam. The print head unit is NOT A FIELD SERVICE ITEM. Therefore, the print head unit should not be opened under any circumstances.

For United States

Laser Safety

This printer is certified as a Class 1 Laser product under the **U.S. Department of Health and Human Service (DHHS)** Radiation Performance Standard according to the Radiation Control for Health and Safety Act of 1968. This means that the printer does not produce hazardous laser radiation.

CDRH Regulations

The **Center for Devices and Radiological Health (CDRH)** of the U.S. Food and Drug Administration implemented regulations for laser products on August 2, 1976. These regulations apply to laser products manufactured from August 1. Compliance is mandatory for products marketed in the United States. The label shown below indicates compliance with the CDRH regulations and must be attached to laser products marketed in the United States.

WARNING: Use of controls, adjustments or performance of procedures other than those specified in this manual may result in hazardous radiation exposure.

All other users

WARNING: Use of controls, adjustments of performance or procedures other than those specified in this manual may result in hazardous radiation exposure.

This is a semiconductor laser. The maximum power of the laser diode is 8.8×10^{-4} W and the wavelength is 770-810 nm.

Safety Information (MSP 3000 Printer)

For Denmark

ADVARSEL: Usynlig laserstråling ved åbning, når sikkerhedsafbrydere er ude af funktion. Undgå udsttelse for stråling.
Klasse 1 laser produkt der opfylder IEC60825 sikkerheds kravene.

For Finland, Sweden

VAROITUS!: Laitteen käyttäminen muulla kuin tässä käyttöohjeessa mainitulla tavalla saattaa altistaa käyttäjän turvallisuusluokan 1 ylittävälle näkymättömälle lasersäteilylle.

WARNING: Om apparaten används på annat sätt än i denna bruksanvisning specificerats, kan användaren utsattas för osynlig laserstråling, som överskrider gränsen för laserklass 1.

VARO: Avattaessa ja suojalukitus ohitettaessa olet alttiina näkymättömälle lasersäteilylle. Aja katso sateeseen.

WARNING: Osynlig laserstråining när denna del är öppnad och spärren är urkopplad. Beakta ej stråien.

For Norway

ADVARSEL: Dersum apparatet brukes på annen måte enn spesifisert i denne bruksanvisning, kan brukeren utsettes for usynlig laserstråling som overskrider grensen for laser klasse 1.

Dette er en halvleder laser. Maksimal effekt til laserdiode er $8.8 \times 10^{-4}W$ og bolgelengde er 770-810 nm.

WARNING LABEL

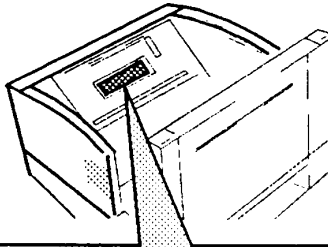

注意- ここを開くと不可視レーザーが出ます。ビームを直接見たり、触れたりしないでください。
 CAUTION- INVISIBLE LASER RADIATION WHEN OPEN AVOID EXPOSURE TO BEAM
 VORSICHT- UNSICHTBARE LASERSTRAHLUNG WENN ABOECKUNG GEÖFFNET NICHT DEM STRAHL AUSSETZEN
 ADVARSEL- USYNLIG LASERSTRÅLING NÅR DEKSEL ÅPNES UNNGÅ EKSPONERING FOR STRÅLEN
 VARO! AVATTAESSA OLET ALTTIINA NÄKYMÄTTÖMÄLLE LASERSÄTEILYLLE ÄLÄ KATSO SÄTEESEEN
 ADVARSEL- USYNLIG LASERSTRÅLING VED ÅBNING UNDGÅ UDSÆTTELSE FOR STRÅLING
 VARNING- OSYNLIG LASERSTRÅLNING NÅR DENNA DEL ÄR ÖPPNAD STRÅLEN ÄR FARLIG

Safety Information (MSP 3000 Printer)

OZONE RELEASE (For all Users)

During printer operation, a small quantity of ozone is released. This amount is not large enough to cause any adverse affects or harm. However, be sure the room where the machine is being used has adequate ventilation, especially if you are printing a high volume of materials, or if the machine is being used continuously over a long period.

WARNING LABEL

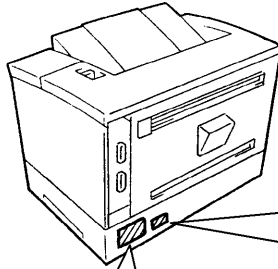

MINOLTA CO., LTD
 2, Higashiakatsuchi, Yawata-cho, Toyokawa-shi,
 Aichi-ken 442, Japan

MANUFACTURED :

THIS PRODUCT COMPLIES WITH 21 CFR
 CHAPTER 1, SUBCHAPTER J. 0948-7191-12

<p>WARNING This device complies with Part 68 of the FCC Rules. Operation is subject to the following two conditions: (1) This device may not cause harmful interference, and (2) this device must accept any interference received, including interference that may cause undesired operation.</p> <p>* This Class A digital apparatus meets all requirements of the Canadian Interference-Causation Classification Requirements. * Cet appareil numérique de la classe A respecte toutes les exigences du Règlement sur le matériel brouilleur du Canada.</p>	<table border="1" style="width: 100%; border-collapse: collapse;"> <tr> <td style="font-size: small;">Model</td> <td style="text-align: right;">MSP 3000</td> </tr> <tr> <td style="font-size: small;">Input</td> <td style="text-align: right;">230 V~ 50 Hz</td> </tr> <tr> <td style="font-size: small;">Total</td> <td style="text-align: right;">750 W 4.0 A</td> </tr> <tr> <td style="text-align: center;"> </td> <td></td> </tr> <tr> <td style="font-size: small;">Serial No.</td> <td style="text-align: right;">MINOLTA CO., LTD. Made In Japan</td> </tr> </table>	Model	MSP 3000	Input	230 V~ 50 Hz	Total	750 W 4.0 A			Serial No.	MINOLTA CO., LTD. Made In Japan
Model	MSP 3000										
Input	230 V~ 50 Hz										
Total	750 W 4.0 A										
Serial No.	MINOLTA CO., LTD. Made In Japan										

Model	MSP 3000
Input	230 V~ 50 Hz
Total	750 W 4.0 A
Serial No.	MINOLTA CO., LTD. Made In Japan

Contents

Chapter 1 Safety Notes

1. Installation Precautions	1-2
Installation Site	1-2
Power Source	1-2
Grounding	1-2
Space Requirements	1-3
Operating Environment	1-5
Using the Printer	1-5
Care of Printer Supplies	1-5
2. Turning the Power On and Off	1-6
Turning ON	1-6
Turning OFF	1-7

Chapter 2 Scanner

1. System Overview	2-2
System Configuration	2-3
2. Parts of the Scanner	2-4
3. Control Panel Keys and Indicators	2-5
Control Panel (Basic)	2-5
Control Panel (Shift Function)	2-11
When (Misfeed/Call-Tech.-Rep. Code) Lights up	2-13
4. Image Processing Functions	2-15
5. Printing/Scanning	2-17
6. Selecting a Projection Lens	2-18
7. Replacing the Projection Lens	2-19
8. Zooming and Focusing	2-20
Zooming of the Screen Image	2-20
Focusing of the Screen Image	2-20
9. Image Rotation	2-21
Manual Rotation (standard): operate by hand	2-21
Auto Image Rotation (option): Motor-driven	2-21
10. Selecting the Film Type	2-22
Auto	2-22
Nega (negative film)	2-22
Posi (positive film)	2-22
11. Selecting the Image Density	2-23
Using Auto Exposure	2-23
Using Manual Exposure	2-23
12. Setting the Number of Prints to be Made	2-24
To Entry the Number of Prints	2-24
Correcting Entry	2-24

13. Selecting the Output Format	2-25
Selecting the paper source	2-25
Selecting the print format	2-26
14. Using Auto Masking	2-27
Selecting Auto Masking	2-27
Operating Conditions for Auto Masking	2-27
15. Manual Masking Panels (Optional)	2-28
16. Using Manual Masking	2-29
Selecting Trimming	2-29
Defining the Print Area	2-29
Clearing a Defined Print (Scan) Area	2-30
Selecting Masking	2-30
17. Using Centering and Fit	2-31
Centering	2-31
Fit	2-31
18. Using the Cycle Print Mode	2-32
Specifying the interval between scanning operations	2-32
Operating in the Cycle Print Mode	2-33
19. Selecting the Connection Mode	2-34
20. Selecting the Resolution	2-35
21. Registering the Job Program	2-36
22. Calling the Job Program	2-37
23. Using the Electrical Zoom	2-38
Zoom +	2-38
Zoom -	2-38
Clearing the Zoom magnification	2-39
24. Adjusting the Illumination of the Screen	2-40
25. Replacing the Projection Lamp	2-41

Chapter 3 MSP 3000 Printer

1. Parts of the Printer	3-2
2. Troubleshooting and Maintenance	3-4
Replenishing the Paper Supply	3-4
Replacing the Toner Cartridge	3-7
Clearing Misfeeds	3-9
Solving Irregular Printing Problems	3-12

Chapter 4 Miscellaneous

1. Specifications	4-2
MS 6000	4-2
MS 6000 + MSP 3000 Printer	4-3

MS 6000 + MSP 2000 Printer	4-4
2. Initial Settings List	4-5
3. System Care	4-8
Cleaning the Scanner	4-8
Cleaning the MSP 3000 Printer	4-9
For Key Operator's Use	4-10

Chapter 1

Safety Notes

This chapter provides precautions for use, a description of the operating environment and conditions as well as instructions on how to turn the system ON and OFF.

1. Installation Precautions

Installation Site

Placement of the unit in the environment described below will ensure optimal performance throughout the long life of service for which it was designed.

- ◆ A well-ventilated place.
- ◆ An area which is free from ammonia or other organic gases.
- ◆ A place which has easy access to a power outlet so that the unit may be easily plugged in and unplugged.
- ◆ Any area free from direct sunlight.
- ◆ A place which is out of the direct air stream of an air conditioner, heater or ventilator and is not subject to extremely high or low temperatures or humidity.
- ◆ A stable location with a flat surface that is not subject to undue vibration.
- ◆ A place that is free from any object that would block the heat exhaust duct of the printer.
- ◆ A place away from curtains or anything else that is easily flammable.
- ◆ An area that is safe from spilled water or other liquids.
- ◆ A dust-free location.

NOTE

If the Scanner is to be located near a window, do not face the Screen towards the window.

Power Source

The power source voltage requirements are as follows:

- ◆ Use a power source with minimal voltage fluctuation.

Power Source:	50Hz-60Hz
Voltage fluctuation:	within $\pm 10\%$
Frequently fluctuation:	within $\pm 3\%$
- ◆ Be careful not to exceed the capacity of the outlet, especially when sourcing other appliances from the same outlet.
- ◆ The outlet should be located near the unit and be easily accessible so that the power cord can be unplugged immediately if necessary.
- ◆ NEVER connect any other appliances or machines by means of a multiple socket to the outlet being used for the unit.
- ◆ If an extension cord is needed, use one with a capacity greater than the power consumption of the unit.
- ◆ Make sure that the power cord and extension cord do not become caught in any mechanism of the system. Do not allow either the power or extension cord to become caught underneath the weight of the unit.

Grounding

To prevent electrical shocks caused by electrical leakage, always ground the printer.

- ◆ Connect the grounding wire to:
 - The ground terminal of the outlet.
 - A grounding contact that complies with the local electrical standards.
- ◆ NEVER connect the grounding wire to a gas pipe, the grounding wire for a telephone, or a water pipe.

Space Requirements

Scanner

There should be a clearance of the following dimensions between the wall and the rear of the unit as well as its right and left sides to provide ample space for the ventilation ports to dissipate heat.

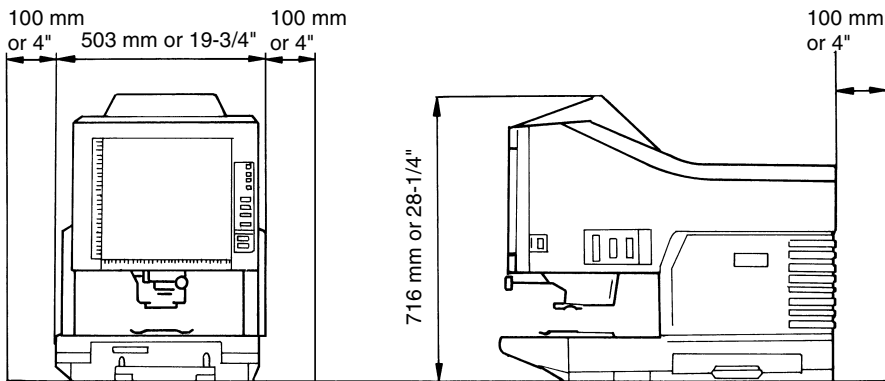

1. Installation Precautions

Printer

For ease of operation, maintenance and replenishment of supplies, the minimum clearance diagrammed below is required. Install the unit in an area that allows easy access.

MSP 3000 Printer

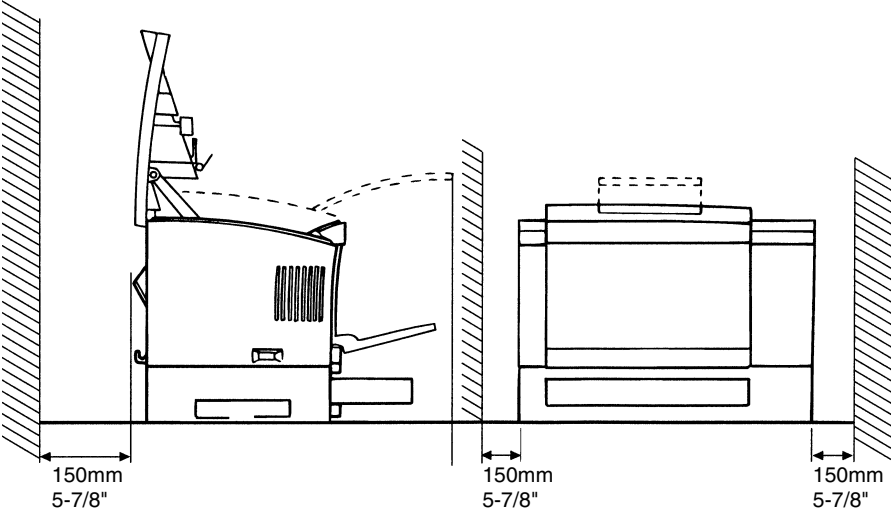

MSP 2000 Printer

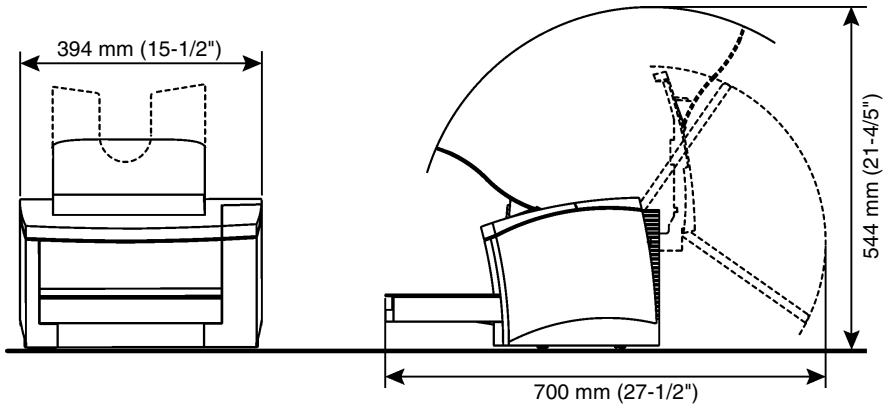

Operating Environment

The environmental requirements for operating the system are as follows:

Temperature: 10 °C to 35 °C (50 °F to 95 °F) with a fluctuation of 10 °C (18°F) per hour.
Humidity: 15% to 85% with a fluctuation of 20% per hour.

Using the Printer

To ensure the optimum performance of the printer, follow the precautions listed below:

- ◆ NEVER open any Cover, or turn OFF the printer during printing.
- ◆ NEVER bring any magnetized object or flammable gas or liquid close to the printer.
- ◆ ALWAYS insert the Power Plug all the way into the outlet.
- ◆ ALWAYS provide good ventilation when making a large number of continuous prints.

NOTE

= Locate the Printer in a Well Ventilated Room =

A minimal amount of ozone is generated during normal operation of the printer. An unpleasant odor may, however, be created in poorly ventilated rooms during extensive printer operations.

For a comfortable, healthy, and safe operating environment, it is recommended that the room be well ventilated.

Care of Printer Supplies

Use the following precautions when handling the printer supplies (Imaging Cartridge, paper, etc.).

- ◆ Avoid storing the supplies in any of the following places:
 - A place subject to direct sunlight. The Imaging Cartridge should not be exposed to fluorescent light, either.
 - A hot place or near an open flame.
 - A humid place.
 - A dusty place.
- ◆ Store paper, which has been removed from its wrapper but not loaded onto the print tray, in a sealed plastic bag in a cool, dark place.
- ◆ Only use Imaging Cartridges that are exclusively designed for use with this printer.
- ◆ Keep supplies out of the reach of children.
- ◆ If your hands become soiled with toner, wash them with soap and water immediately.

NOTE

Whenever the Imaging Cartridge is removed from the printer, immediately wrap it in a heavy cloth to protect it from light.

2. Turning the Power On and Off

Turning ON

1 Press the Power Switch of the scanner to the I (ON) position.

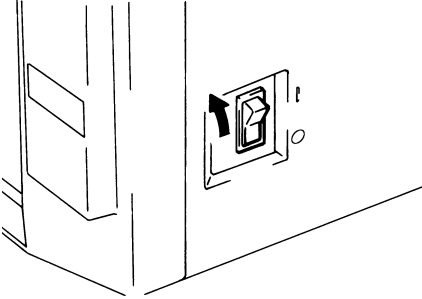

2 Press the Power Switch of the printer to the I (ON) position.

MSP 3000 Printer

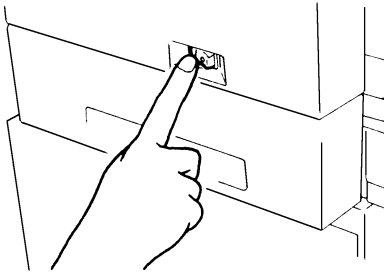

MSP 2000 Printer

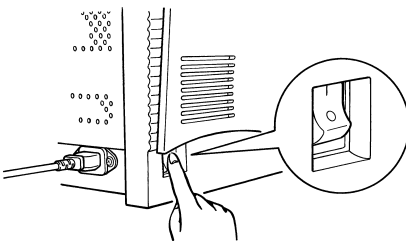

3 The Control Panel displays a blinking “1” and the machine starts to warm up. The machine is ready to read data when the “1” stops blinking.

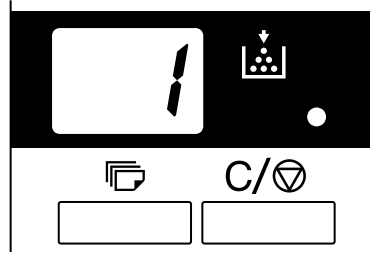

Useful Tips

If you load the film in the film carrier and press the start button while the printer is warming up, you can scan and memorize the film image of about 9 pages (Letter or A4 size/400dpi) into this system. And then, printer allows that print process to be started as soon as the printer completes warming up. At this time, both ends of Exposure Display blink.

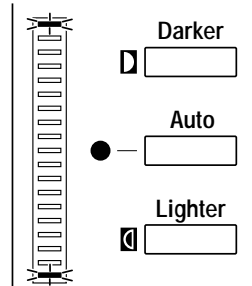

If you want to disable this function, ask your authorized Technical Representative to make change the system setting.

Turning OFF

- 1 Press the Power Switch of the scanner to the O (OFF) position.

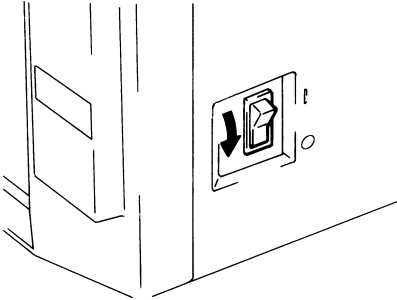

- 2 Press the Power Switch of the printer to the O (OFF) position.

MSP 3000 Printer

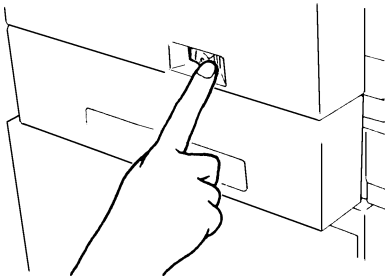

MSP 2000 Printer

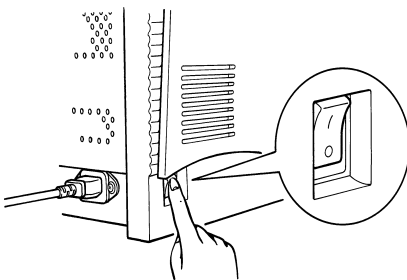

NOTE

The printer and scanner can be turned ON and OFF at the same time by employing a cord that is equipped with an on/off switch saving both time and energy.

** Make sure that all cords used comply with the specified ratings of the unit.*

Auto Power Save and Auto Projection Lamp OFF Functions

This system provides two functions that help to decrease power consumption: one is the Auto Power Save function that automatically shuts down power to the printer heater; the other is the Auto Projection Lamp OFF function that automatically turns OFF the Projection Lamp of the scanner. Both are activated when the system is left idle for a given period of time.

These functions may be disabled or enabled. When enabled, timing can be selected from either 30 min. or 60 min.

When the system is in the Auto Power Save mode, each outside segment of the Multi-Print Display LEDs light up sequentially, clockwise.

* The default setting for the Auto Power Save and Auto Projection Lamp OFF functions is "Disabled." Consult your Minolta authorized dealer for more information.

Memo

Chapter 2

Scanner

This chapter identifies different parts of the Scanner and explains its operation.

1. System Overview

Scanner

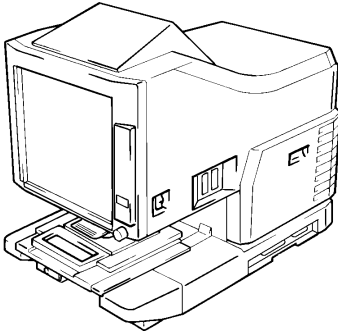

Projection Lens

Single Lens

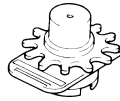

7.5x
Zoom Lens

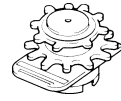
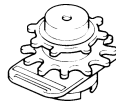

9-16x

13-27x

23-50x

- Prism Unit
- Manual Frame Masking Kit
- Counter Kit
- PC Interface Kit
- Foot Switch Kit

Film Carrier

Auto-retrieval Controller

FC-5



RFC-21

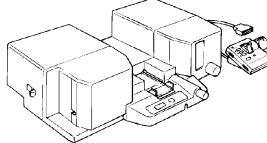

MARS C-4



RFC-9B

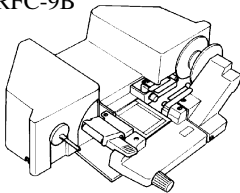

RFC-15A

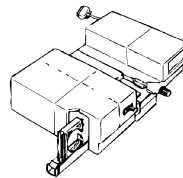

MARS MINI 2

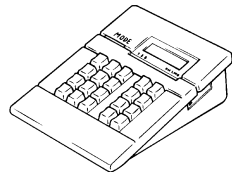

UC-2

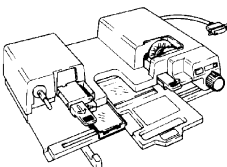

RFC-15M

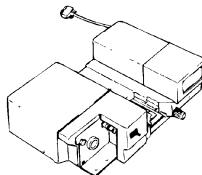

System Configuration

This Scanner is available in the following configurations.

PR Mode (MS 6000 + Printer)

The Scanner is connected to a dedicated printer, allowing scanned images to be printed out directly.

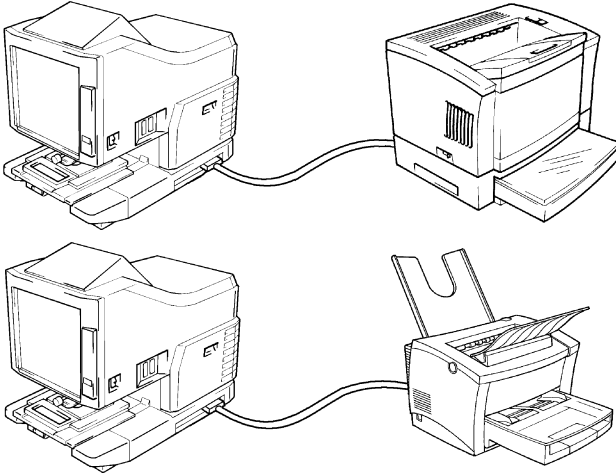

NOTE

Each scanner is designed exclusively for use with its respective Printer. Contact your Minolta authorized dealer in order to change the scanner that is connected to your printer. For instructions on operating the MSP 2000 printer, see the Operator's Manual that came with the printer.

PC Mode (MS 6000 + Personal Computer)

The Scanner is connected to a personal computer and the scanned images can be uploaded to the computer. An optional PC interface kit required for connection to a personal computer. Contact your authorized dealer for details.

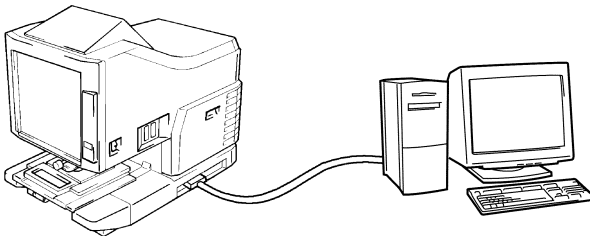

Connection to a personal computer and printer can be switched using Control Panel. Refer to "Selecting the Connection Mode" on Page 2-34.

2. Parts of the Scanner

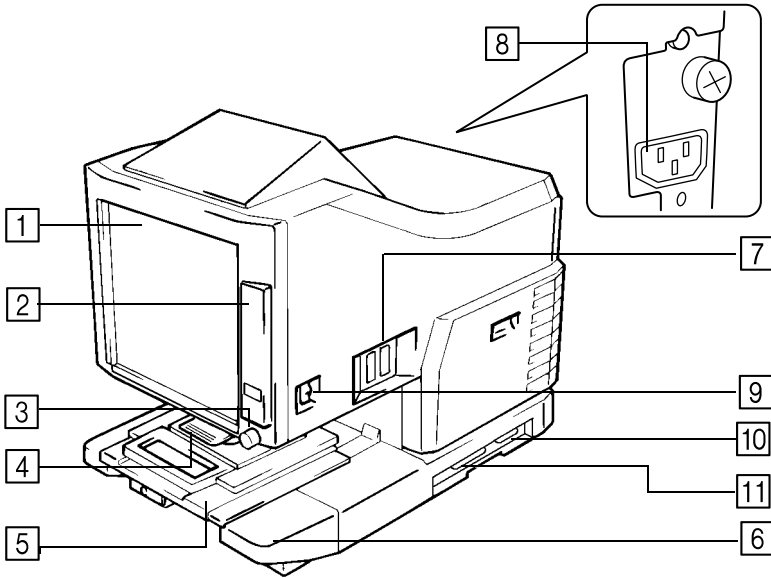

- | | | |
|-----------|------------------------------------|--|
| 1 | Screen: | The image taken from the film is projected here for viewing. The frame on the Screen marks the data reading range. |
| 2 | Control Panel: | Many operations are controlled from the keys and indicators provided here. |
| 3 | Image Rotation Knob: | Used to turn the Prism Unit built into the Scanner, turning the image on the Screen. |
| 4 | Projection Lens (Optional): | Used to change the size and adjust the focus of the image on the Screen. |
| 5 | Fiche Carrier 5 (Optional): | Supports the viewing of microfiche. |
| 6 | Projection Lamp Unit: | Contains a Mirror and Lens which project the film image onto the Screen. |
| 7 | Connectors: | Provides connection points for the various options (Roll Film Carrier and Controller). |
| 8 | Power Cord Socket: | Plug the power cord furnished with the Scanner into this socket. |
| 9 | Power Switch: | Used to turn power to the unit ON and OFF. |
| 10 | Printer Connector: | Connects the scanner to the printer through an interface cable. |
| 11 | SCSI Connector (Optional): | Connects the scanner to the Personal Computer through a SCSI cable. The PC Interface Kit (Optional) is required. |

3. Control Panel Keys and Indicators

Control Panel (Basic)

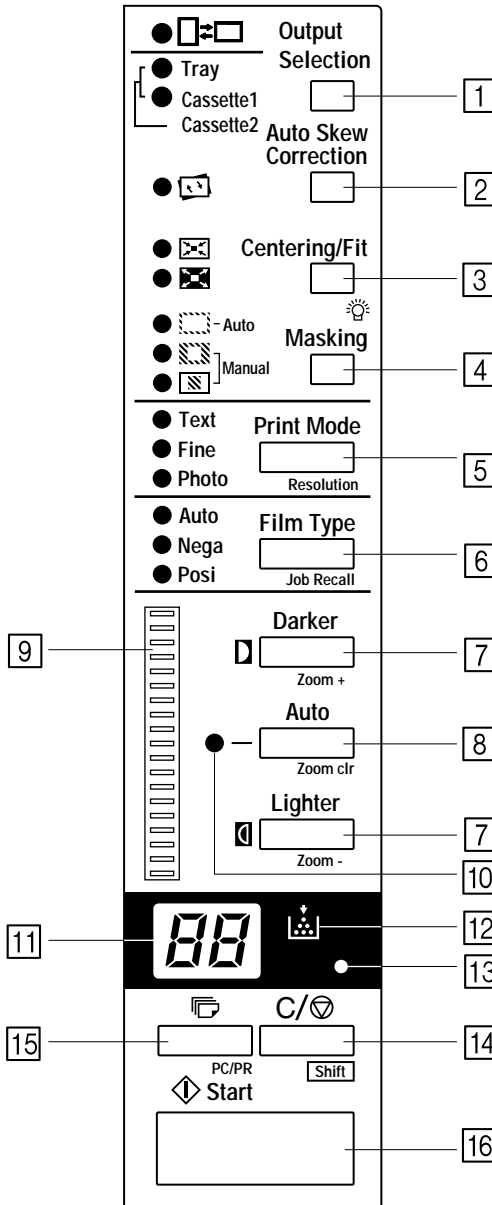

3. Control Panel Keys and Indicators

1 Size Selection Key:

Select the paper feeding source according to the format of the film image that is being reflected in the screen.



when this lamp is lit:

A 90 degree image rotation is performed during printing.

The image on the screen will be rotated 90 degrees. Consequently, the screen image will be oriented horizontally on paper that is positioned lengthwise, and vertically on paper that is positioned crosswise.

when this lamp is blink:

The Auto Film Format Select Print function is available when Letter (or A4) size paper is placed in both lengthwise and crosswise positions in the paper feeding tray and paper feeding cassette. Paper that best suits the format of the image on the screen will be used for printing.

If you would like to use this function, please contact your Minolta authorized dealer.

Tray: Prints the film image on paper fed from the print tray.

Cassette1: Prints the film image on paper fed from the cassette 1.

Cassette2: Prints the film image on paper fed from the cassette 2. (when the Tray and Cassette1 indicators are both lit)

2 Auto Skew Correction Key:

This key is used to turn the Auto Skew Correction function ON or OFF. When this function is applied, the Auto Skew Correction indicator will turn on and the system will correct any skew of the image during printing.

* After printing, the skew can be reset or retained. Contact your Minolta authorized dealer for more information.

3. Control Panel Keys and Indicators

3 Centering/Fit Key:

When this key is pressed, the setting rotates from OFF to the Centering and Fit functions.

When Auto Masking, Trimming, or Masking are set to off, Auto Masking will automatically be enabled when Centering is selected.



Centering:

Places a screen image that had been searched using Auto masking or an image that has been trimmed in the center of the page.



Fit:

Enlarges a screen image that had been searched using Auto masking or an image that has been trimmed to fit the page.

*When Masking  is selected or when the Scanner is connected to the PC, this mode cannot be used.

3. Control Panel Keys and Indicators

4 Masking Key:

When pressed, this key rotates from OFF to the Auto, Trimming or Masking functions.

Each time this key is pressed, selection is switched in order of "OFF → Auto Masking → Manual Trimming → Manual Masking → OFF."

 Auto Masking:

The Auto Masking function will omit the frame (non-image area) of a printed film image.

- The previous Centering/Fit setting is applied whenever ON is selected from the OFF state.
 - If OFF is selected from the ON state, Centering/Fit is disabled.
- * Auto Masking is not applicable with the Masking or Trimming settings.

 Trimming:

When ON is selected, the image is printed (scanned) with the non-image area (frame) automatically masked.

 Masking:

Prints only the image outside of the area that is defined on the Screen.

- If Trimming is selected from the OFF state, the previously entered settings for Centering/Fit and Manual Masking are applied.
 - From Trimming, when Masking is selected, the Centering/Fit setting is disabled and the previous settings for the Masking area are applied.
 - The manual masking area will be cancelled whenever OFF is selected from the Masking state.
- * Neither Trimming nor Masking are available through the Auto Masking function.
- * Trimming and Masking cannot be set when the Scanner is connected to the PC.

5 Print Mode Key:

Allows you to fine tune the image quality of the print according to the original being used. Rotate between Text, Fine and Photo with every press of this key.

- 1) Text: For use with text images.
- 2) Fine: For use with lower grades of film.
- 3) Photo: For use with photo images.

3. Control Panel Keys and Indicators

- 6 Film Type Key:** Rotates between Auto, Nega, and Posi each time the key is pressed.
- 1) Auto: The scanner automatically determines between the film type options of negative or positive for print production.
 - 2) Nega: Select when using negative film. Dark and light values of the print will be reversed.
 - 3) Posi: Select when using positive film. Dark and light values of the print will be consistent with the image on film.
- 7 Exposure Adjustment Keys:** Use this key to adjust the image density of the image to be printed during the Auto or Manual Exposure mode. The Darker key supports darker image density and the Lighter key supports lighter image density.
- 8 Exposure Mode Key:** Press to select between the Auto or Manual Exposure mode.
- 9 Exposure Display:** Indicates the current density level of the printed image.
- 10 Exposure Mode Indicator:** Auto Exposure mode is indicated when the green Auto light is on. The green Auto light turns off when the Scanner is in the Manual Exposure mode.
- 11 Multi-Print Display:** Shows the number of prints set to be made. Also displays corresponding codes in the event of a malfunction or paper misfeed. The blinking number in this display indicates the Scanner in operation.
- 12 Add Toner Indicator:** Blinks when the Imaging Cartridge or Toner Cartridge of the Printer is running out of toner and lights up when the cartridge has completely run out of toner.
* PR mode only.

3. Control Panel Keys and Indicators

13 Memory Input Key:

To store one of the following functions into the memory of the Scanner, first set one of the functions on Control Panel and then press this button with the head of a pen or other device. The next time the scanner is turned ON, that function will appear as a default setting until a new one is entered. (Maximum three kind of setting can be memorized.)

- 1) Negative or positive
- 2) Print mode
- 3) Output Format
- 4) Print image density
- 5) Exposure mode
- 6) Centering or Fit
- 7) Masking
- 8) Auto Skew Correction
- 9) Horizontal Area setting
- 10) Vertical Area setting
- 11) Electrical Zoom
- 12) Resolution

NOTE

If you do not press the pinhole for at least 60 seconds after a setting has been made with the Auto Reset function set to ON, the previous setting remains valid.

14 Clear/Stop Key:

Press to clear the setting on the Multi-Print Display, resetting it to “1” or to stop a multi-print cycle.

15 Multi-Print Keys:

This key is used to set the number of prints when printing continuous, multiple pages.

The value of this setting increases by one (1, 2, 3...) with every push of the key. (Maximum 19)

* PR mode only.

16 Start Key:

Press to make a print (scan) of the image shown on the Screen.

Control Panel (Shift Function)

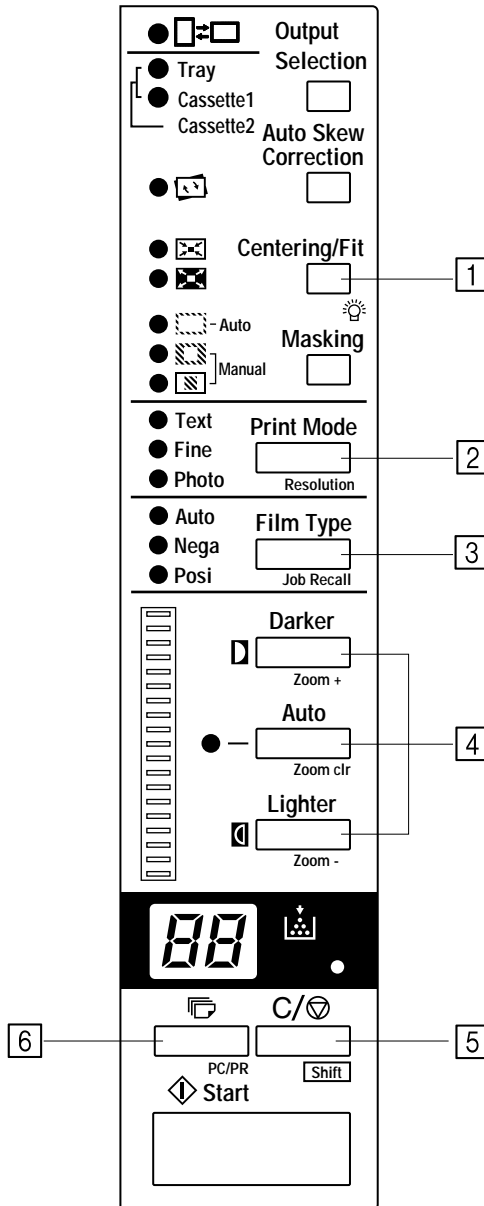

3. Control Panel Keys and Indicators

- 1 Lamp Illuminance Key:** When this key is pressed together with the Shift Key, the illumination of the screen is adjusted. When this key is continuously pressed, the screen is gradually darkened until it is turned OFF. When any key is pressed then, the illumination returns to the maximum level.
- 2 Resolution Key:** When this key is pressed together with the Shift Key, the resolution of the Scanner is set.
When the Scanner is connected to the Printer: 4H and 6H
When the Scanner is connected to the PC: 2H, 3H, 4H, 6H and 8H
* 4H represents 400dpi and 6H represents 600dpi.
- 3 Job Recall Key:** When this key is pressed together with the Shift Key, the program registration locations (1J, 2J and 3J) are called. Each time this key is pressed while the Shift Key is held down, the display is switched in order of 1J → 2J → 3J.
- 4 Zoom Key:** When this key is pressed together with the Shift Key, the electrical zoom magnification is set.
Zoom+: When this key is pressed together with the Shift Key, the magnification is increased by an increment of 0.01X (up to 2.00X).
Zoom clr: When this key is held down together with the Shift Key for one second, the standard magnification is resumed.
Zoom-: When this key is pressed together with the Shift Key, the magnification is decreased by a decrement of 0.01X (down to 0.50X).
- 5 Shift Key:** Executes an expansion function when being pressed together with the intended function key.
- 6 PC/PR Key:** When this key is pressed together with the Shift Key, the connection to the PC or to the Printer is selected.
* This key is not valid unless the PC interface kit (optional) is installed.

When (Misfeed/Call-Tech.-Rep. Code) Lights up

This indicates that a paper misfeed or malfunction has occurred in the system. Check the code shown on the Multi-Print Display and perform the misfeed clearing procedure or the Call-Tech.-Rep. procedure.

Malfunions Procedure

Code	Description
<i>L2</i>	The Projection Lamp is burned out. Replace the lamp. ☞ See p. 2-32. * If the lamp goes out during a print cycle, a blank print may be output.
<i>E1</i>	The power to the printer is off or there is a problem with the connection of the interface cable to the printer. Turn on the printer or make sure that the interface cable is securely connected.
<i>E2</i>	The upper cover of the printer is not closed. Make sure that it is completely closed.
<i>PE</i>	The printer is out of paper. Load some paper into the paper cassette. ☞ See p. 3-4.
<i>PC</i>	The Scanner is connected to the PC and ready for scanning by pressing the Start Key. This display is blinking when the Scanner is in operation.
<i>Pc</i>	The Scanner is not connected to the PC. Turn ON the PC or connect the Scanner to the PC with the interface cable.

Misfeed Clearing Procedure

Locate the misfeed using the code and perform the misfeed clearing procedure.

Code	Description
<i>P0</i>	The wrong size paper has been loaded in the Paper Feeding Tray. Load 8-1/2"×11" (A4). This code also appears when two or more sheets of paper are taken up at the same time.
<i>P1</i>	A misfeed near the paper take-up section.
<i>P2</i>	A misfeed near the Imaging Cartridge.
<i>P3</i>	A misfeed near the Fusing Unit

3. Control Panel Keys and Indicators

Call-Tech.Rep.Procedure

A malfunction has occurred in the system.

Location	Code	Description
Scanner	C1	Optical path switching failure
	C2	A Scanning malfunction
	C4	A Fan Motor malfunction
Printer	C6	A Fusing Unit malfunction
	C7	An Laser malfunction
	C8	A Polygon Motor malfunction
	C9	A Main Drive Motor malfunction
	CA	A Fan Motor malfunction
Scanner Printer	Cb	A Communication malfunction (Printer)
	CL	A Printer Clock malfunction
Scanner PC	CC	A Communication malfunction (PC)

NOTE

After turning the power to the system OFF and unplugging its power cord from the electrical outlet, contact your Minolta authorized dealer, being sure to provide him or her with the currently displayed code (Above code).

4. Image Processing Functions

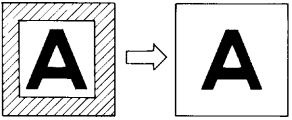
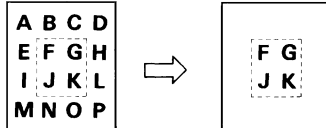
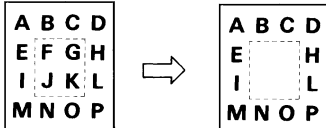
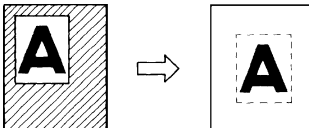
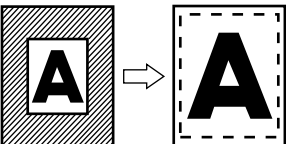
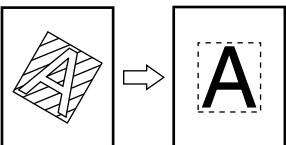
Screen Image → Print Image	Description
<p>Auto Masking (1 Frame)</p> 	<p>The system masks the black bands that run along the edges of the image.</p>
<p>Trimming (1 Frame)</p> 	<p>The system masks everything but the center of the image. * The Manual Frame Masking Kit (option) is required.</p>
<p>Masking (1 Frame)</p> 	<p>The system masks the center of the image appearing on the screen through the Manual Frame Masking Panel function. * The Manual Frame Masking Kit (option) is required.</p>
<p>Auto Centering</p> 	<p>The system generates an image that is centered on the printed page, from an image on the screen with a masked frame.</p>
<p>Fit</p> 	<p>Fit the image on the Screen onto the entire surface of the print.</p>
<p>Auto Skew Correction</p> 	<p>The machine automatically correct any skew of the image when printed.</p>

4. Image Processing Functions

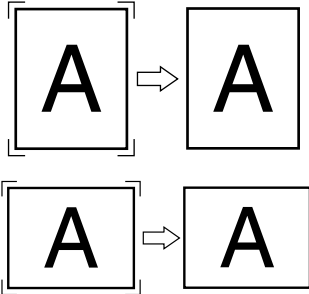
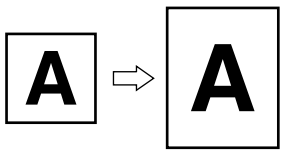
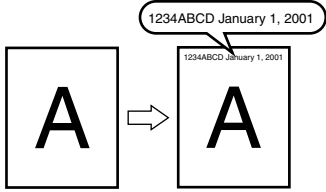
Screen Image → Print Image	Description
<p>Auto Film Format Select Print</p> 	<p>The machine automatically determines the format (portrait or landscape) of the image on the Screen and prints it as necessary.</p> <p>If you would like to use this function, please contact your Minolta authorized Technical Representative.</p>
<p>Image Zoom</p> 	<p>The system magnifies the screen image according to the size of paper being used. The range of magnification is 1.55x for Ledger, 1.27x for Legal, 1.41x for A3 and 1.22x for B4 sized paper.</p> <p>* This function is only available when MSP 3000 Printer is connected.</p>
<p>Imprint</p> 	<p>Time, date, and messages can be included on printout.</p> <p>If you would like to use this function, please contact your Minolta authorized Technical Representative.</p>

5. Printing/Scanning

Here is an outline of the printing procedure:

1. Load the film

The procedure for loading film is determined by the type of Film Carrier (optional) that is being used. Review the Operator's Manual that came with your Film Carrier for more information.

2. Select and replace the Lens See page 2-18, 2-19.

Select the appropriate lens for the type of film being used and install it in the Scanner.

3. Select the Connection Mode See page 2-34

Select either PC connection mode or PR connection mode.

4. Zooming, focusing and image rotation See page 2-20, 2-21.

Use the Zooming Ring Dial to frame a desired range of the image on the screen for printing.

Use the Focus Ring Dial to sharpen the clarity of the image on the screen.

Use the Image Rotation Knob to orient the image on the screen.

* Press the Auto Skew Correction key to have the skew of the image automatically corrected.

5. Select either negative or positive printing See page 2-22.

Select between negative or positive printing according to the type of film that is being used.

6. Select the image density See page 2-23.

Use Auto Exposure to automatically determine the optimum image density for the application.

The image density can also be set manually by using the Exposure Adjustment keys (Darker or Lighter).

7. Enter the number of prints to be made See page 2-24.

Using the Multi-Print keys, enter the number of prints to be made.

8. Selecting the Output Format See page 2-25.

Using the Output selection key, set the paper source and print format setting.

9. If required, adjust the image processing functions.

Auto Masking  See page 2-27.

Manual Masking (Masking or Trimming)  See page 2-29.

Image Centering or Fit  See page 2-31.

10. Press the Start key.

 Start

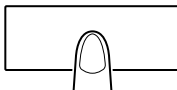

The printing or scanning of the image appearing on the screen is initiated after the Start key is pressed.

6. Selecting a Projection Lens

Projection Lenses come in the following four types. Select the one that corresponds to the film being used.

- Projection Lens Types
- 1 Type 1: 7.5×
 - 2 Type 1: 9 to 16×
 - 3 Type 2: 13 to 27×
 - 4 Type 3: 23 to 50×

Film		Scanning Size
		8-1/2"×11" (A4)
35mm	Half	<input type="checkbox"/> 2
	Full	<input type="checkbox"/> 1
16mm	Half	<input type="checkbox"/> 3
	Full	<input type="checkbox"/> 2
Source Document	60	<input type="checkbox"/> 3
	98	<input type="checkbox"/> 3 or <input type="checkbox"/> 4
	325	<input type="checkbox"/> 4
	420	<input type="checkbox"/> 4
COM	63	<input type="checkbox"/> 3
	70	<input type="checkbox"/> 3
	80	<input type="checkbox"/> 3 or <input type="checkbox"/> 4
	84	<input type="checkbox"/> 3 or <input type="checkbox"/> 4
	120	<input type="checkbox"/> 3 or <input type="checkbox"/> 4
	208	<input type="checkbox"/> 4
	270	<input type="checkbox"/> 4

This list shows the standard types of film and the recommended zoom ratios of lenses to be used with the machine. The size and format of one frame of film may vary depending on the shooting conditions.

Zoom the lens in and out to find the optimum ratio that will fit the scanning size.

7. Replacing the Projection Lens

To install a Lens with a magnification different from that already installed in the machine, follow the procedure given below.

- 1 Take hold of the Prism Holder Lever and pull it up to raise the Prism Holder.

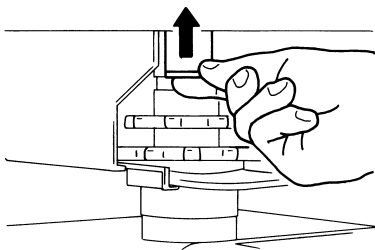

- 2 Pull out the Lens Unit.

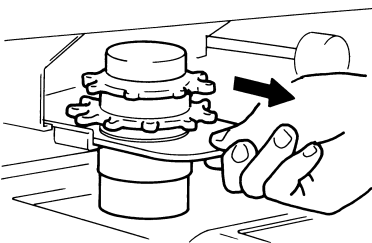

- 3 Slide the Lens Unit into the machine along the Lens Guide.

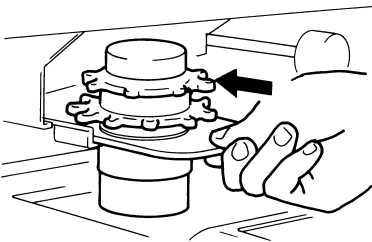

- 4 Pull out the Brightness Select Lever and slide it to a position appropriate for the type of the Projection Lens loaded in the machine.
The lever should click into position.

NOTE

Brightness on the Screen is uneven if the Brightness Select Lever is not placed in a position corresponding to the type of the Projection Lens being used. Be sure to place the Lever into the correct position according to the type of Projection Lens.

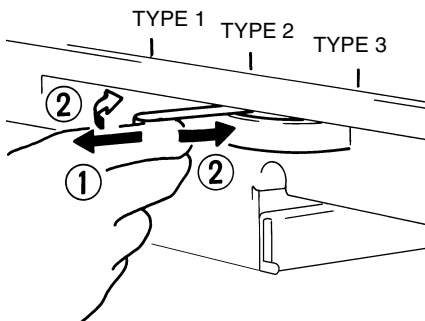

8. Zooming and Focusing

Zooming of the Screen Image

- 1 Rotate the Zooming Ring Dial to bring the image on the Screen into print size frame.

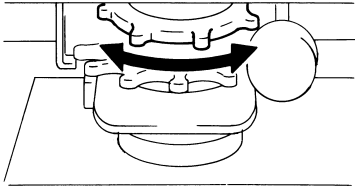

Focusing of the Screen Image

- Rotate the Focusing Ring Dial to bring the image on the Screen into focus.

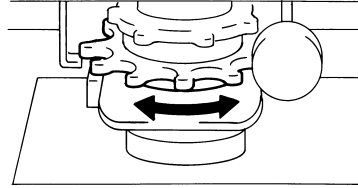

- 2 Marked on the Screen are the size frame markers corresponding to the paper size (8-1/2" × 11" or A4). Zoom the film image so that it fits inside the markers.

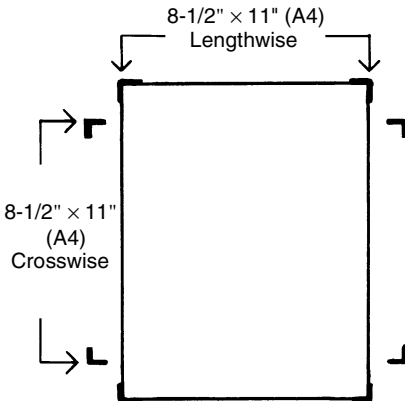

9. Image Rotation

To turn the image on the Screen, turn the Image Rotation Knob.

Auto Image Rotation:

Turn the Image Rotation Knob on the bottom right of the Screen Frame to turn the image.

The greater the turning angle of the Image Rotation Knob, the faster the turning speed.

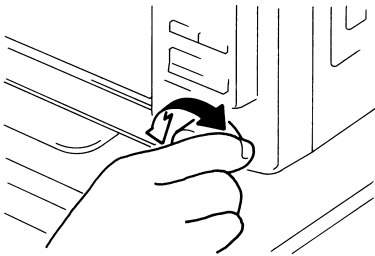

When the Image Rotation Knob is turned while holding down the Shift Key, the image quickly rotates by 90°.

Auto Skew Correction

If the Auto Skew Correction Key is turned ON, the system will automatically correct any skew of the image when printed.

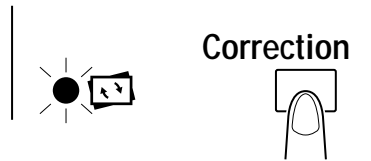

NOTE

This function supports angle rotations of up to 30°.

10. Selecting the Film Type

Auto

I The system will automatically determine the polarity of the film being used when Auto is selected with the Film Type key.

Nega/Posi

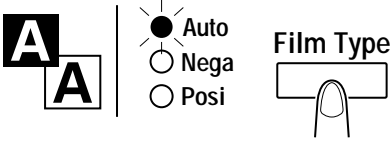

Posi (positive film)

I If positive film is to be used, press the Film Type Key to select Posi.

Posi

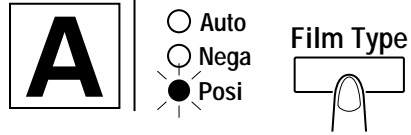

NOTE

- The system cannot determine the polarity of certain types of film. Should this occur, the film type should be selected manually.
- The system does not detect exterior conditions such as when the glass surface of the Carrier is dirty or scratched.

Nega (negative film)

I If negative film is to be used, press the Film Type Key to select Nega.

Nega

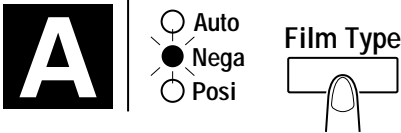

11. Selecting the Image Density

Using Auto Exposure

- 1 Depress the Exposure Mode Select Button as necessary to select the Auto Exposure Mode.
The LED to the left of the key lights up green when the Auto Exposure mode is selected.

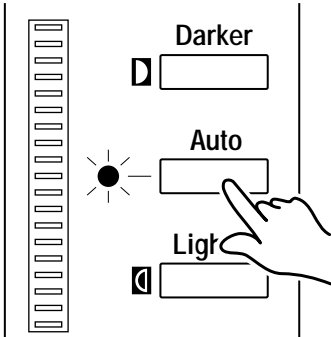

- 2 Depress the appropriate Exposure Adjustment Button, either LIGHTER or DARKER, to set the desired image density, or exposure, level.

Depress LIGHTER to make the image lighter.

Depress DARKER to make the image darker.

When the LIGHTER and DARKER keys are depressed at once, the exposure level comes at the center.

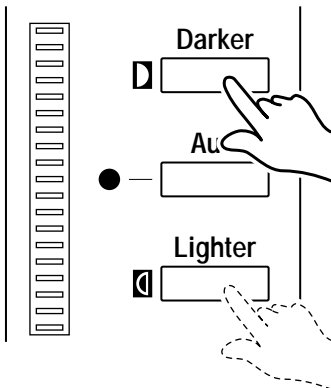

Using Manual Exposure

- 1 Depress the Exposure Mode Select Button as necessary to select the Manual Exposure mode.
The LED to the left of the key lights down green when the Auto Exposure mode is selected.

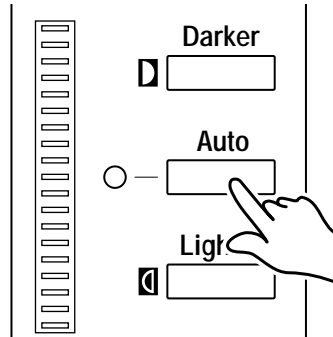

- 2 Depress the appropriate Exposure Adjustment Button, either LIGHTER or DARKER, to set the desired image density, or exposure, level.

Depress LIGHTER to make the image lighter.

Depress DARKER to make the image darker.

When the LIGHTER and DARKER keys are depressed at once, the exposure level comes at the center.

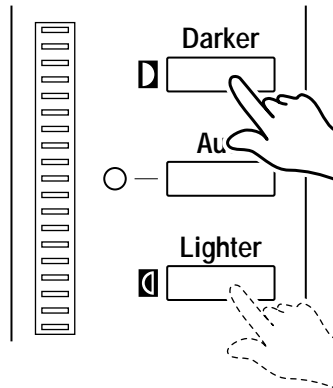

12. Setting the Number of Prints to be Made

To Entry the Number of Prints

Set the desired number using the Multi-Print Key.

NOTE

This function is only available on the PR mode.

The number that can be entered is 19 max.

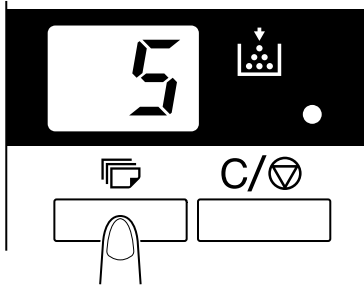

Correcting Entry

To correct an entry, depress the Clean Button, which resets the number on the Multi-Print Display to "1".

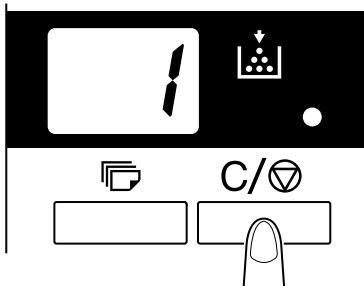

13. Selecting the Output Format

Press the Output Selection Key to select the paper source and print format.

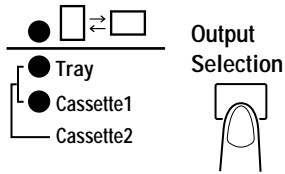

Selecting the paper source

Tray: Prints the film image on paper from the print tray.

Cassette 1: Prints the film image on paper from the cassette 1.

Cassette 2: Prints the film image on paper from the cassette 2.
(When the Tray and Cassette 1 indicators are both lit.)

The standard magnification is fixed according to the selected size of the paper from the paper feeder.

Paper size	A3	B4	A4	B5	Ledger	Legal	Letter
Standard magnification	1.41x	1.22x	1.00x	1.00x	1.55x	1.27x	1.00x

For A3, B4, Ledger and Legal, zoom is made by the above standard magnification and printed within the on-screen range 8-1/2" x 11" (A4).

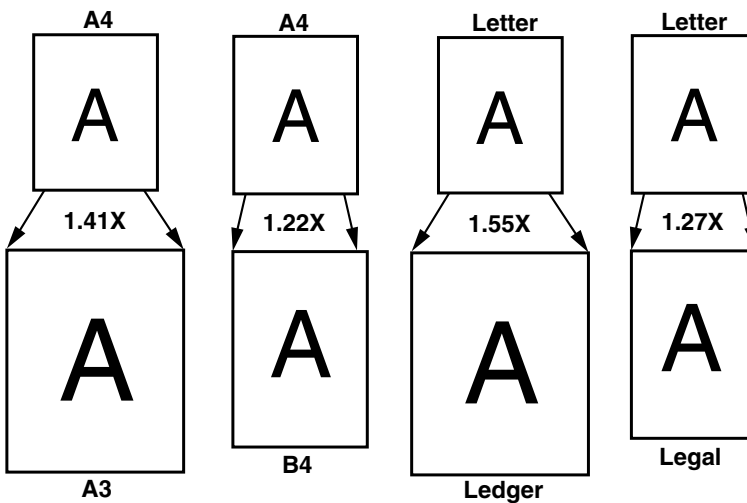

13. Selecting the Output Format

Selecting the print format

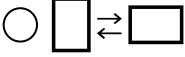
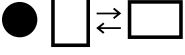
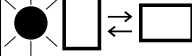
Display	Paper Feeding	Description
Light OFF 	Lengthwise	Prints the on-screen lengthwise area.
	Crosswise	Prints the on-screen crosswise area.
Light ON 	Lengthwise	Prints the on-screen crosswise area.
	Crosswise	Prints the on-screen lengthwise area.
Blinking 	Lengthwise	Prints the on-screen image by automatically judging whether it is lengthwise or crosswise.
	Crosswise	

14. Using Auto Masking

The Auto Masking function prevents the frame (non-image area) of a film image from appearing on the print.

Selecting Auto Masking

1 Press the Auto Masking key to turn ON this function.

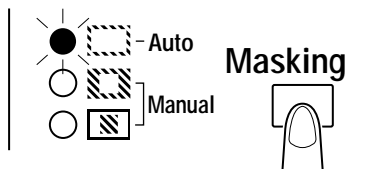

Operating Conditions for Auto Masking

- A. The image area of the screen must provide at least 45mm horizontally and vertically.
- B. The width of the frame to be masked must be at least 10mm.

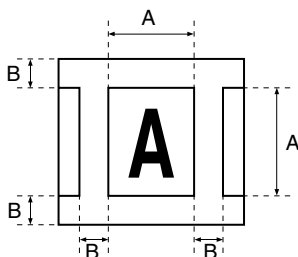

NOTE

If the film image on the screen does not meet the above requirements, the Auto Masking function will not work properly.

Auto Masking is a frame erasing feature. It cannot remove an image from in between two separate frames.

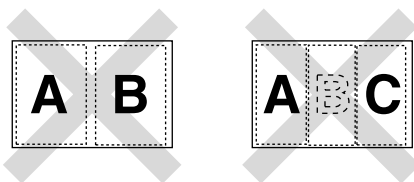

15. Manual Masking Panels (Optional)

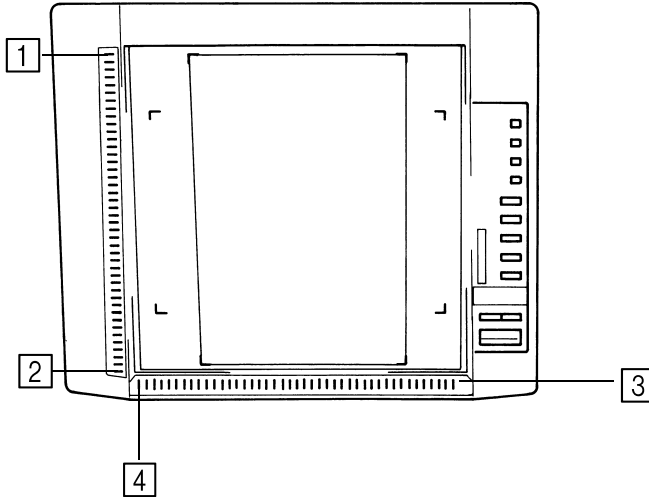

- 1 Vertical Area Indication Panel:** Use to specify the vertical print (scan) area of the image on the screen. There are 42 lights placed at 7mm intervals. The lights create a pattern when lit specifying the area on the screen that will be printed.
- 2 Vertical Area Clear Key:** Press to clear a previously specified vertical print (scan) area.
- 3 Horizontal Area Indication Panel:** Use to specify the horizontal print (scan) area of the image on the screen. There are 42 lights placed at 7mm intervals. The lights create a pattern when lit specifying the area on the screen that will be printed.
- 4 Horizontal Area Clear Key:** Press to clear a previously specified horizontal print (scan) area.

16. Using Manual Masking

The optional Manual Frame Masking Kit allows you to specify an area for printing of the displayed image through two separate features, Trimming and Masking.

Selecting Trimming

- 1 Press the (manual) Masking key to select  (Trimming).

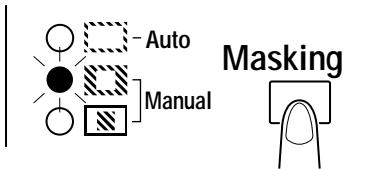

- 2 The lights on the panel light up according to the currently selected paper size and print position.

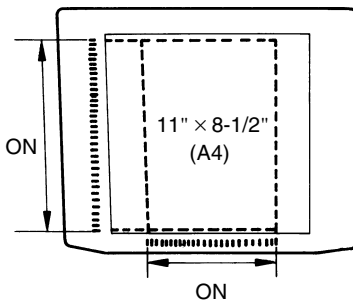

NOTE

It is possible to print the area specified by the green lights.

Defining the Print Area

- 1 Define the end points for both the vertical and horizontal areas of the image on the screen using the green lights on the area indication panels.

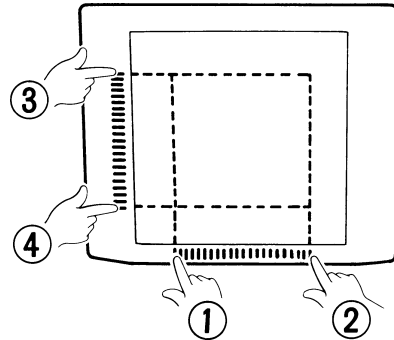

NOTE

The points defining the vertical and horizontal area can be selected in any order.

Blinking lights on the indication panels indicate an improper entry of the specified area. Specify the area again.

16. Using Manual Masking

Clearing a Defined Print (Scan) Area

- I** Press the Vertical and Horizontal Area Clear keys to clear the defined print (scan) area.
- 1: Horizontal Area Clear Key
 - 2: Vertical Area Clear Key

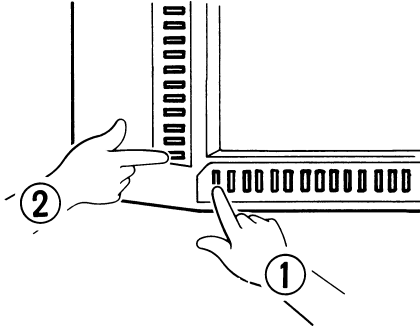

Selecting Masking

Press the (manual) Masking key to select  (Masking) when you want to mask a given area of the image.

The basic operation for manual Masking is similar to Trimming. Please refer to the previous procedures on Trimming and defining areas for instructions on performing manual Masking.

17. Using Centering and Fit

Once the image on the Screen has been either “manually trimmed” or “auto masked”, the Image Centering function moves the image to the center of the print. The Fit function however, fits the image on the Screen onto the entire surface of the print.

	Screen Image	Print Image	
Centering		Centering: OFF 	Centering: ON
		Fit: OFF 	Fit: ON

Centering

- 1 Press the Centering/Fit key to turn ON Centering and then press the Start key.

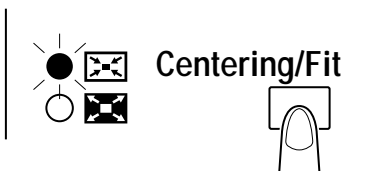

Fit

- 1 Press the Centering/Fit key to turn ON Fit and then press the Start key.

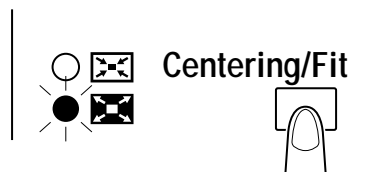

NOTE

Centering/Fit mode cannot be used if (Masking) is selected.

NOTE

Fit mode cannot be used when the Scanner is connected to the PC.

18. Using the Cycle Print Mode

This function automatically scans the next image following a preset period of time. Images are manually loaded onto the Carrier Glass in between cycles.

This is a system setting that must be entered by an authorized dealer.

If you want to use the Cycle Print Mode, ask your Tech. Rep. to make the necessary system setting. Then you can perform the following operations.

* This function is only available on the PR mode.

Specifying the interval between scanning operations

- 1 Press the Multi-Print Key to change the value to "A". This enables the Cycle Print Mode. Press the Multi-Print Key to set the interval of time between scan operations. (Refer to the diagram below).

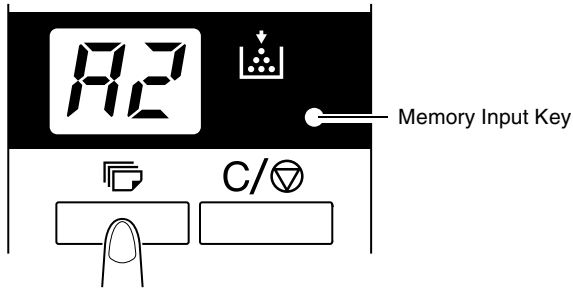

- 2 Press the Memory Input key to store the currently selected interval setting of the Cycle Print Mode into the memory.

Value	1	2	3	4	5	6	7	8	9	0
Period (sec.)	0.5	1.0	1.5	2.0	2.5	3.0	3.5	4.0	4.5	5.0

Operating in the Cycle Print Mode

1 After entering the Cycle Print Mode, press the Start key to start.

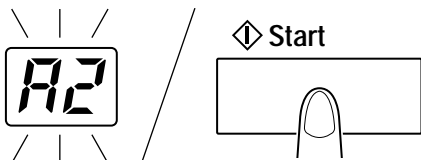

3 While the pause function is enabled, it is possible to exit the Cycle Print Mode by pressing the Clear key a second time (the value displayed in the “No. of Copies” display will change to a “1”.)

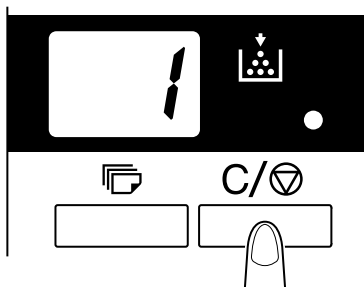

NOTE

- After the first scanning operation has finished, the system will automatically scan the next image following a preset period of time. The system will continue to operate until the Cycle Print Mode is canceled.
- The “No. of Copies” value flashes during the “scanning” and “waiting” operations.
- The next scanning job can be started manually by pressing the Start key before the system automatically initiates the same job.

2 To pause an operation during the Cycle Print Mode, press the Clear key (the “No. of Copies” value will switch from a blinking display to a constant display).

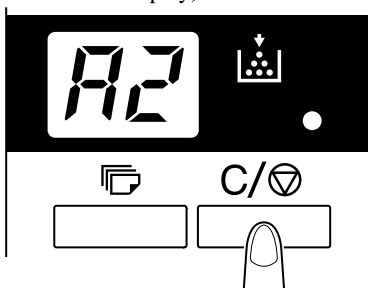

19. Selecting the Connection Mode

The Scanner connection can be selected between PR (connection to the Printer) and PC (connection to the PC).

* For the connection to the PC, the optional interface kit is required.

1 Hold down the Shift Key and the PC/PR Key together for over one second.

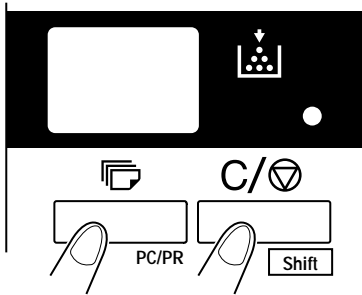

PC mode: When the display is switched from Multi-Print to PC, the connection to the PC is valid.

PR mode: When the display is switched from PC to Multi-Print, the connection to the Printer is valid.

20. Selecting the Resolution

The resolution for scanning (printing) can be selected.

- 1** Press the Shift Key and the Resolution Key together. The present resolution is displayed.

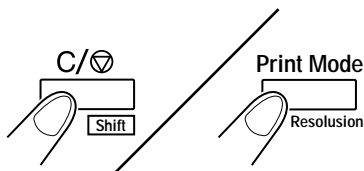

- 2** Press the Resolution Key while holding down the Shift Key to set the resolution.

Connection mode	Resolution	Display
PR mode	400 dpi	4H
	600 dpi	6H
PC mode	200 dpi	2H
	300 dpi	3H
	400 dpi	4H
	600 dpi	6H
	800 dpi	8H

21. Registering the Job Program

The present setting state can be registered in up to 3 program registration locations (1J, 2J and 3J).

- 1 Press the Memory Input Key in the Setting mode. 1J starts blinking.

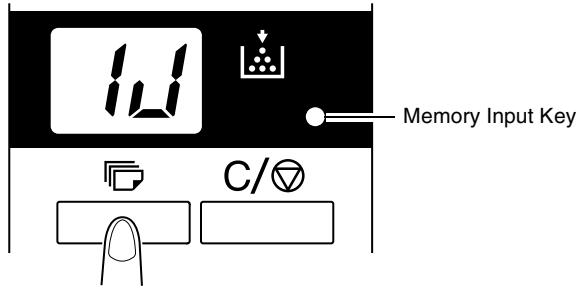

To change the program registration location, press the Multi-Print Key. The display is switched in order of 1J → 2J → 3J → 1J.

- 2 Select the program registration location (1J, 2J or 3J), and press the Memory Input Key again.
- 3 When all LEDs on the control panel light up and then the normal display is resumed, the program registration is over.

The program can be registered up to 3 programs for the PR connection and up to 3 programs for the PC connection.

22. Calling the Job Program

The registered Job program can be called.

- 1** Press the Shift Key and the Job Recall Key together.

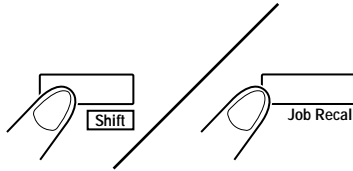

- 2** Each time the Job Recall Key is pressed while the Shift Key is held down, the display is switched in order of 1J → 2J → 3J.
- 3** When the desired setting is displayed, unhand the keys.

23. Using the Electrical Zoom

In addition to the zooming by the Lens, the Electrical Zoom function has been provided for magnifying the image when it is printed.

Zoom +

When the Zoom+ key is pressed together with the Shift Key, the magnification is increased by an increment of 0.01X (up to 2.00X).

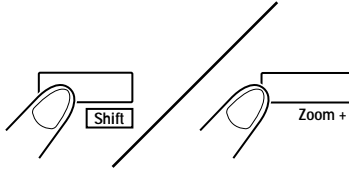

Zoom -

When the Zoom- key is pressed together with the Shift Key, the magnification is decreased by a decrement of 0.01X (down to 0.50X).

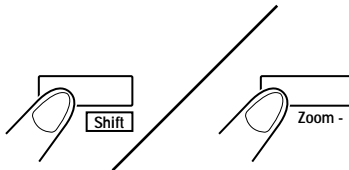

NOTE

The Zoom magnification is displayed in the Multi-Print Display to 2 decimal places.

The Zoom magnification level is displayed in the Exposure Display.

Example: When the magnification is 0.50x, it is displayed as 50. When the magnification is 1.50x, it is displayed as 50 also.

Clearing the Zoom magnification

When the Zoom clr key is held down together with the Shift Key for over one second, the standard magnification is resumed.

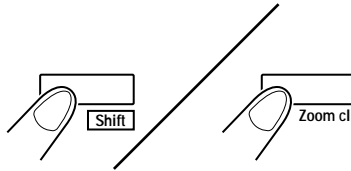

The standard magnification is fixed according to the selected paper size.

Paper size	A3	B4	A4	B5	Ledger	Legal	Letter
Standard magnification	1.41x	1.22x	1.00x	1.00x	1.55x	1.27x	1.00x

NOTE

When the Zoom magnification is changed, the display is made in the Multi-Print Display as follows.

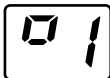

When it is returned to the standard magnification, this display goes off.
When the Zoom function is used, the Multi-Print can be set only up to 9.

24. Adjusting the Illumination of the Screen

The illumination of the screen can be adjusted.

- 1** Hold down the Shift Key and the Illumination Key together to adjust the illumination of the screen.

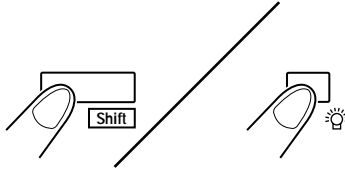

The screen is gradually darkened until it is turned OFF. When any key is pressed, the illumination returns to the maximum level.

25. Replacing the Projection Lamp

Use the following procedure to replace the Projection Lamp whenever a reduction in brightness on the screen is detected or whenever the lamp burns out. Make sure that the replacement lamp is specified for use with this scanner. (DC20V 150W DDL type)

If the Projection Lamp should burn out during a print operation, an L2 code will appear and the print job will stop (a blank piece of paper may be output depending upon the stage of the job). Once the system detects that the Projection Lamp has burnt out, the scan job will be cancelled. If the system is operating in the Cycle Print Mode, the scanning operation will stop.

CAUTION

Do not touch with bare hand and extremely hot Projection Lamp immediately after the machine has been turned OFF.

- 1 Place the Power Switch in the OFF position and slide the Projection Unit out of the machine.

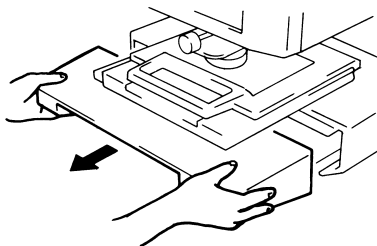

- 3 Remove the Projection Lamp from the Lamp Socket.

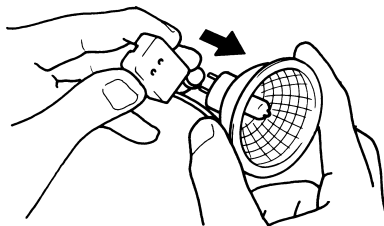

- 2 Remove the Projection Lamp from the Lamp Holder.

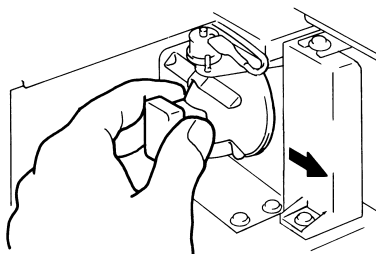

25. Replacing the Projection Lamp

- 4** Insert a new Projection Lamp so that the mark on its base is facing upwards. Make sure that the new Projection Lamp is inserted securely so that there is no gap between the Projection Lamp and the Lamp Socket.

NOTE

Do not touch the reflector mirror surface of the Projection Lamp. Fingerprints, smudges or debris should be wiped clean with a soft, dry cloth.

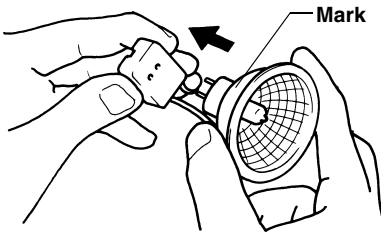

- 5** Insert the new Projection Lamp all the way into the Lamp Holder.

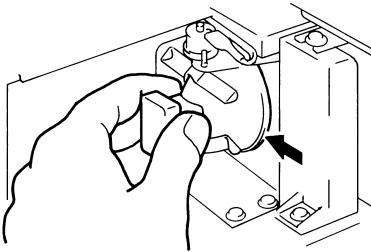

- 6** Slide the Projection Unit back into the machine.

NOTE

If the Projection Unit is not properly installed, power will not be supplied and the machine will not operate.

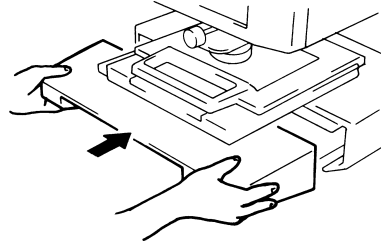

- 7** Turn the Power Switch ON.

Chapter 3

MSP 3000 Printer

This chapter identifies the different parts of the system and explains the MSP 3000 printer's operational procedures.

1. Parts of the Printer

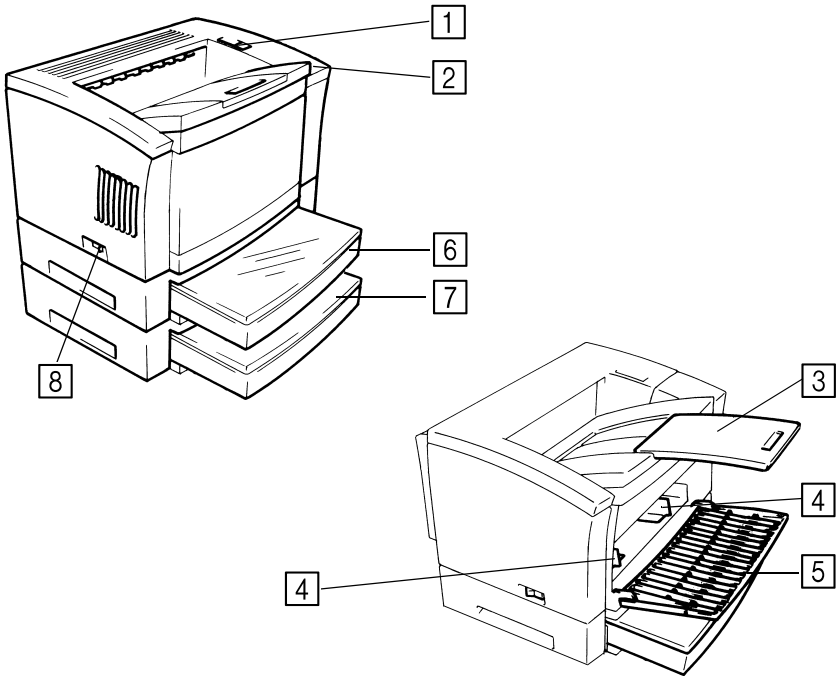

- | | | |
|----------|---------------------------------------|---|
| 1 | Upper Unit Lock Release Lever: | Use to open the Upper Unit. |
| 2 | Power Indicator: | Light indicates when the Printer is turned ON. |
| 3 | Print Tray: | Prints are output from the Printer, face down onto this tray which can hold up to 500 sheets of standard paper. |
| 4 | Paper Guides: | Slide the guides to secure the paper stack. |
| 5 | Paper Feeding Tray:
(Tray) | Capable of holding up to 150 sheets of 8-1/2" × 11" (or A4) paper. |
| 6 | Cassette 1: | Capable of holding up to 250 sheets of standard-size paper. (8-1/2" × 11", 11" × 17", 8-1/2" × 14" or A3, B4, A4) |
| 7 | Cassette 2:
(option) | Capable of holding up to 250 sheets of standard-size paper. (8-1/2" × 11", 11" × 17", 8-1/2" × 14" or A3, B4, A4) |
| 8 | Power Switch: | Use to turn the Printer ON and OFF. |

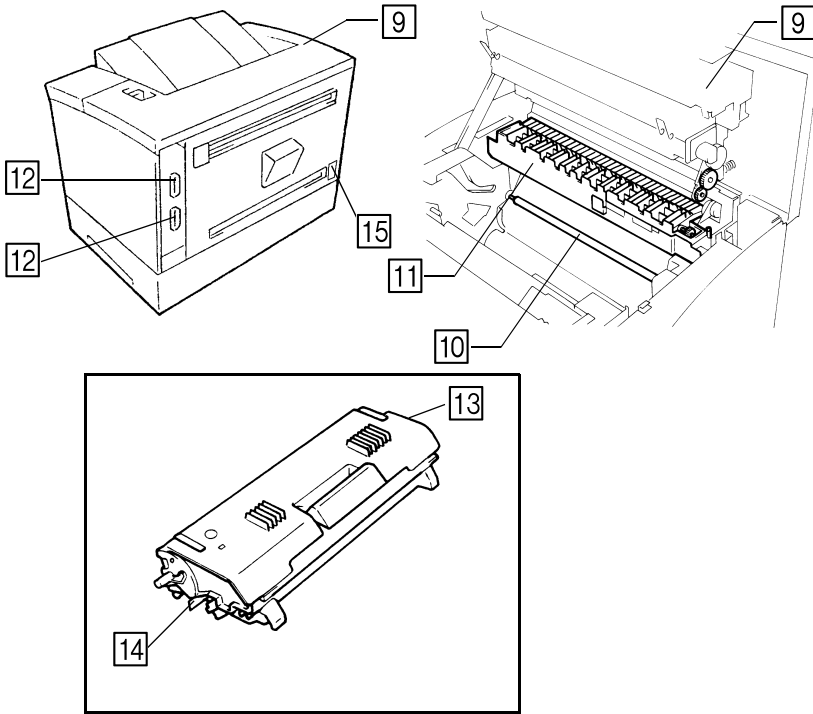
**9 Upper Unit:**

Open to replace the Imaging Cartridge and to clear misfed sheets of paper.

10 Image Transfer Roller:

Transfers the image onto the sheet of paper. Be careful to avoid touching it with your bare hands.

11 Fusing Unit:

Permanently fixes the image onto the sheet of paper.

12 Interface Connectors:

Facilitates connections for the Scanner.

* The Printer has two connectors to facilitate connection with two separate Scanner units.

13 Imaging Cartridge:

Where the image is generated for transfer onto the sheet of paper. Be careful to avoid touching it with your bare hands.

14 Seal:

Remove the seal before installing the new cartridge.

15 Power Cord Socket:

The power cord is plugged into this socket.

2. Troubleshooting and Maintenance

Replenishing the Paper Supply

Use only the following types of paper:

Type Plain and recycled paper (weight 16 to 24 lbs. / 60 to 90 g/m²)

Size Standard sizes: 11" × 17", 8-1/2" × 11", 8-1/2" × 14" (or A3, B4, A4).

Capacity Paper Feeding Tray:
8-1/2" × 11" (or A4) plain and recycled paper
Up to 150 sheets

Paper Cassette:
8-1/2" × 11", 11" × 8-1/2", 8-1/2" × 14", 11" × 17" (or A3,B4, A4)
plain and recycled paper
Up to 250 sheets

Loading Paper into the Paper Feeding Tray (Tray)

- 1** Swing down the Paper Feeding Tray.

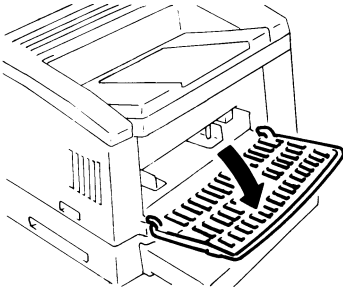

- 2** Fan the paper stack thoroughly and align the edges.



- 3** Load the paper stack face up in the tray and adjust the Paper Guides to secure the paper stack.

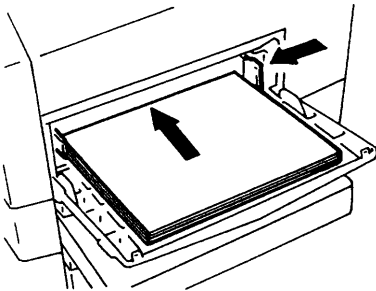

NOTE

- Make sure that the paper stack does not exceed the Maximum Level Indicator.

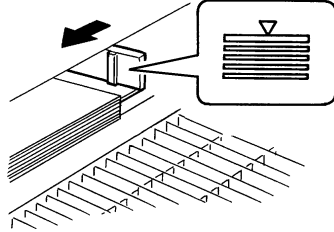

- Load a new paper stack only after the old one has run out.

- 4** Close the Paper Feeding Tray.

2. Troubleshooting and Maintenance

Loading Paper in the Paper Cassette

- 1** Pull the cassette out of the Printer and open the Cover.

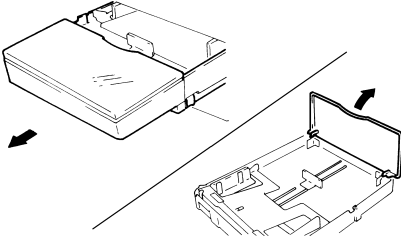

- 2** Press down the Paper Lifting Plate until it locks. Fan the paper stack thoroughly, align the edges, and place the paper in the cassette.

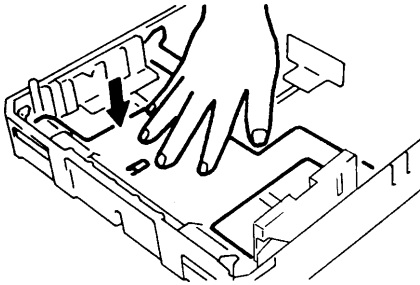

- 3** Secure the paper stack in the Paper Cassette with the Paper Guides.

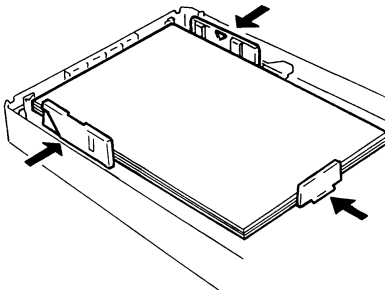

NOTE

- Make sure that the paper stack does not exceed the Maximum Level Indicator.
- Load a new paper stack only after the old one has run out.

- 4** Close the Cover and insert the cassette into the Printer.

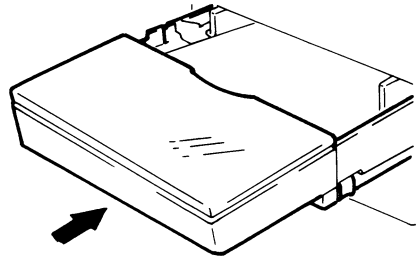

Replacing the Toner Cartridge

- 1** Open the upper unit by pulling the Upper Unit Lock Release Lever forward.

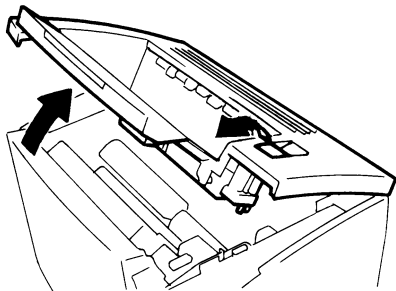

- 2** Remove the old Imaging Cartridge from the printer.

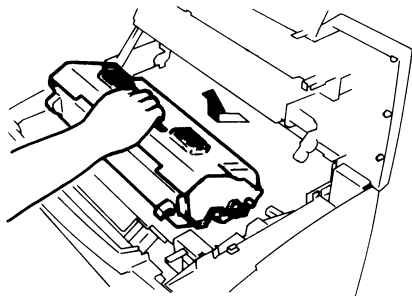

- 3** Take a new Imaging Cartridge out of the box. Holding it with both hands, shake it well in the directions indicated by the arrows.

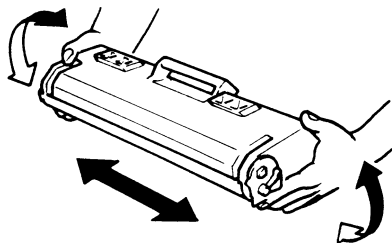

- 4** Remove the seal from the Imaging Cartridge by pulling it steadily straight out.

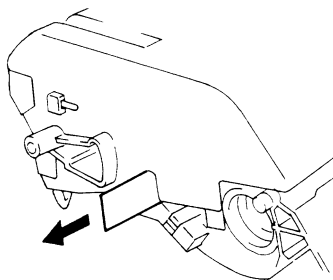

- 5** Shake the Imaging Cartridge four or five more times as shown to evenly distribute the toner inside.

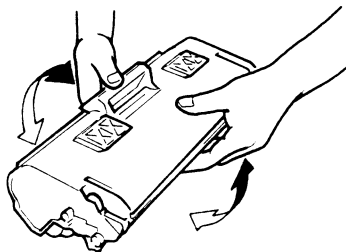

- 6** Slide the pins located on both sides of the Imaging Cartridge into the grooves of the printer as shown and gently push the Imaging Cartridge securely into place.

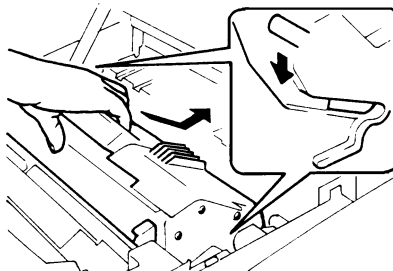

2. Troubleshooting and Maintenance

7 Close the Upper Unit.

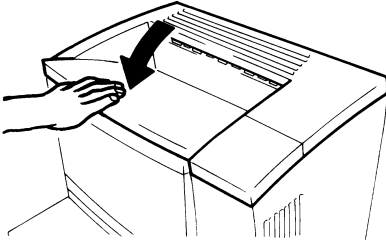

NOTE

Push the Print Tray in before opening the Upper Unit.

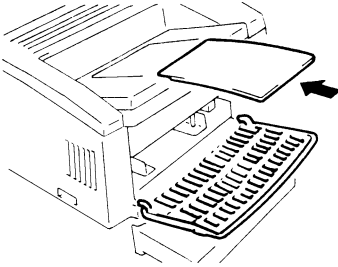

Clearing Misfeeds

- If the Misfeed Code (P0) lights up:
The Paper Feeding Tray is loaded with paper other than 8-1/2"×11" (or A4). Load 8-1/2"×11" (or A4) paper in the tray and open and close the Upper Unit.
- If the Misfeed Code (P1, P2, or P3) lights up:
A misfeed has occurred in the Printer. Clear the sheet of misfed paper by following the procedure given below.

CAUTION

The Fusing Unit inside the printer becomes very hot during operation. To avoid a burn, be very careful not to touch it.

Clearing a Misfeed from the Paper Feeding Tray

- 1 Open the Upper Unit by pulling the Upper Unit Lock Release Lever forward.

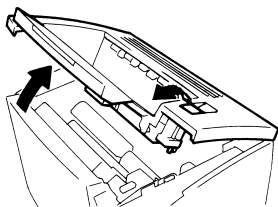

NOTE

Push the Print Tray in before opening the Upper Unit.

- 2 Remove the Imaging Cartridge.

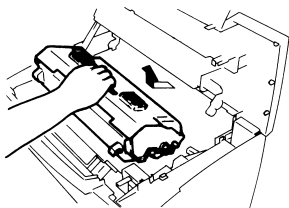

NOTE

Be sure to cover the Imaging Cartridge with a heavy cloth to protect it from light when it is removed from the Printer.

- 3 Remove the sheet(s) of paper that caused the misfeed from the Paper Feeding Tray.

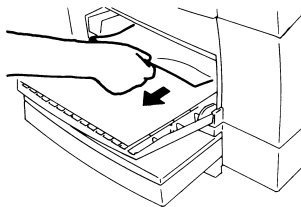

- 4 Check that no misfed paper is left in the Printer and then reinstall the Imaging Cartridge.

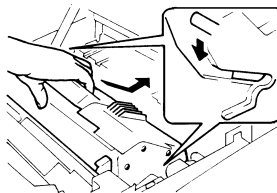

- 5 Close the Upper Unit.

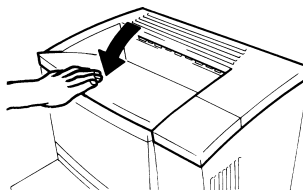

2. Troubleshooting and Maintenance

Clearing a Misfeed from the Paper Cassette

- 1** Open the Upper Unit by pulling the Upper Unit Lock Release Lever forward.

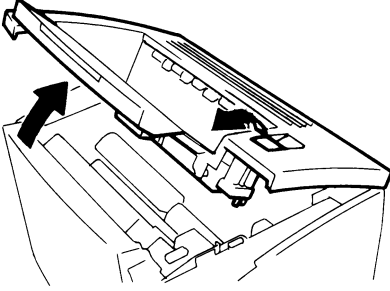

NOTE

Push the Print Tray in before opening the Upper Unit.

- 2** Remove the Imaging Cartridge.

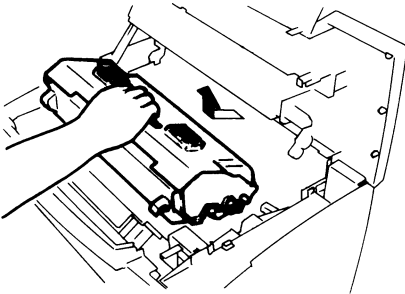

NOTE

Be sure to cover the Imaging Cartridge with a heavy cloth to protect it from light when it is removed from the Printer.

- 3** Remove the sheet(s) of paper that caused the misfeed as shown.

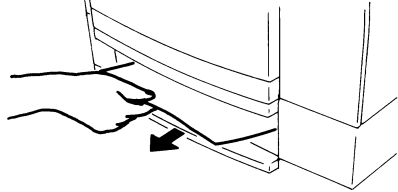

- 4** Check that no misfed paper is left in the Printer and then reinstall the Imaging Cartridge.

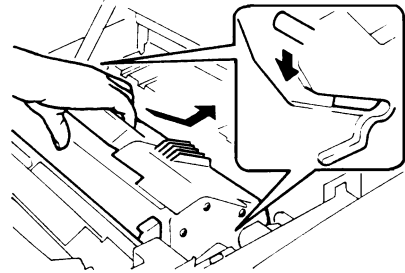

- 5** Close the Upper Unit.

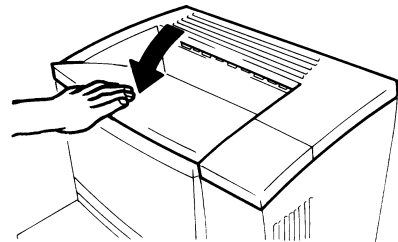

Clearing a Misfeed from inside the Printer

- 1** Open the Upper Unit by pulling the Upper Unit Lock Release Lever forward.

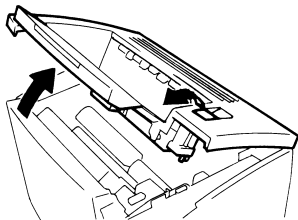

NOTE

Push the Print Tray in before opening the Upper Unit.

- 2** Remove the Imaging Cartridge.

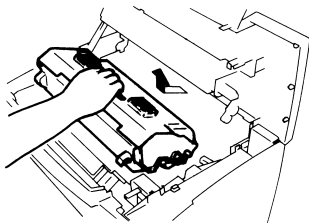

NOTE

Be sure to cover the Imaging Cartridge with a heavy cloth to protect it from light when it is removed from the Printer.

- 3** If the misfeed occurred before the sheet of paper entered the Fusing Unit, gently pull the misfed sheet up and out as shown.

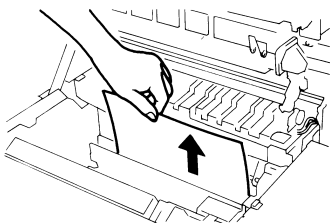

- 4** If the misfeed occurred after the sheet of paper entered the Fusing Unit, gently pull the misfed sheet toward you and out as shown.

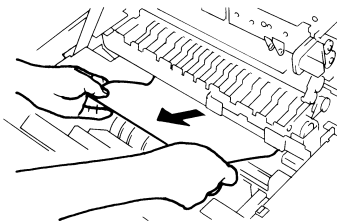

NOTE

- Since the toner has not yet been fixed onto the sheet of paper, be careful not to soil your hands or clothes when pulling out the misfed sheet.
- Do not remove the misfeed by pulling on the sheet of paper toward the output end of the Fusing Unit as shown.

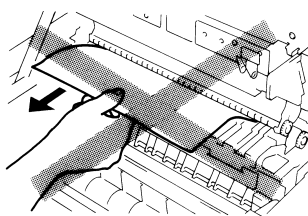

- 5** Reinstall the Imaging Unit and close the Upper Unit.

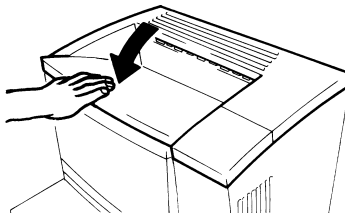

2. Troubleshooting and Maintenance

Solving Irregular Printing Problems

Use the following procedures to fix minor printing problems. If print quality does not improve after implementing the procedures below, contact your Minolta authorized dealer.

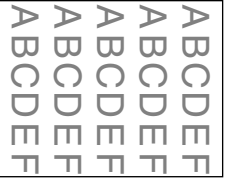
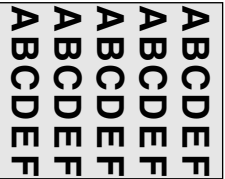
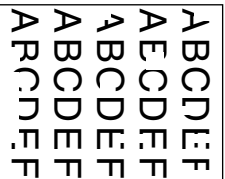
Symptom	Cause	Action
Light image 	Print density is not properly set. Toner in the Imaging Cartridge is running out.	Change the print density setting as necessary. Replace the Imaging Cartridge with a new one.
Dark image 	Print density is not properly set.	Change the print density setting as necessary.
Partial void image 	The paper in the tray is damp.	Replace the damp paper with fresh, dry paper.

2. Troubleshooting and Maintenance

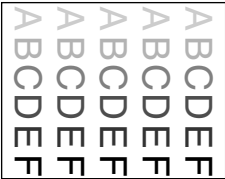
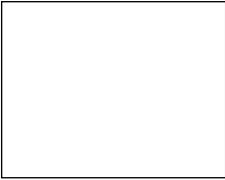
Symptom	Cause	Action
<p data-bbox="165 204 385 233">Uneven image density</p>  <p data-bbox="367 320 412 368">➔</p>	<p data-bbox="441 204 716 288">Toner in the Imaging Cartridge is not evenly distributed.</p>	<p data-bbox="730 204 996 288">Remove the Imaging Cartridge, shake it several times and replace.</p>
<p data-bbox="219 470 331 499">Blank print</p>  <p data-bbox="367 587 412 635">➔</p>	<p data-bbox="441 470 716 523">The Printer has malfunctioned.</p>	<p data-bbox="730 470 996 523">Contact your Minolta authorized dealer.</p>

Memo

Chapter 4

Miscellaneous

This chapter contains the specifications of the unit as well as provides care and maintenance instructions.

1. Specifications

MS 6000

Type:	Desk-Top Type Microfilm Scanner
Resolution:	200, 300, 400, 600, 800 dpi (PC Mode) 400, 600 dpi (PR Mode: When MSP 3000 Printer is connected) 400 dpi (PR Mode: When MSP 2000 Printer is connected)
Output Scale:	PC Mode: Binary, Grayscale (Option) PR Mode: Binary
PC Interface:	SCSI-2 (Option)
Exposure Control:	Automatic & Manual
Type of Film:	Microfiche, Jackets, Aperture Cards, 16mm & 35mm Roll Film, 16mm Film Cartridges.
Screen:	12" × 12" (300 mm × 300 mm)
Magnification:	7.5×, 9×-16×, 13×-27×, 23×-50×
Image Rotation:	Prism Rotation, Carrier Rotation (Microfiche)
Print Size:	8-1/2" × 11" (or A4) Crosswise, 11" × 17" (or A3) Lengthwise 8-1/2" × 11" (or A4) Lengthwise, 8-1/2" × 14" (or B4) Lengthwise
Power Consumption:	350W
Dimensions	19-3/4"(W) × 32-3/8"(D) × 28-1/4"(H) (503 × 821 × 716 mm)
Weight	86 lbs. (39kg)
Standard Accesories:	Power Cord, Printer Cable, Prism Unit, Operator's Manual (this manual)
Options:	Lenses, Fiche Carrier 5, Universal Carrier UC-2, Roll Film Carrier 9B, Roll Film Carrier 15A/15M, Roll Film Carrier 21, MARS Controller 4, MARS Mini Controller 2, Manual Frame Masking Kit, Counter Kit, Foot Switch Kit, Grayscale Memory Board, PC Interface Kit

* Specifications subject to change without notice.

MS 6000 + MSP 3000 Printer

Type:	Microfilm Scanner Printer System
Printing Method:	Laser Electrostatic
Resolution:	400, 600 dpi
Developing System:	Minolta Fine Micro-Toning (Fine-MT) System
Print Size:	8-1/2" × 11" (or A4) Crosswise, 11" × 17" (or A3) Lengthwise 8-1/2" × 11" (or A4) Lengthwise, 8-1/2" × 14" (or B4) Lengthwise
Print Speed:	20 sheets per minute (8-1/2" × 11" or A4: Crosswise)
First Print Time:	13 seconds (8-1/2" × 11" or A4: Crosswise)
Warm-up Time:	Less than 70 seconds
Multiple Printing:	1-19 sheets (LED countdown identification)
Paper Supply:	Automatic Feeding System Paper Feeding Tray (250 sheets max.) Paper Cassette 1 (250 sheets max.) Paper Cassette 2 (250 sheets max.): Option
Power Consumption:	Less than 1100W (Scanner: 350W, Printer: 750W)
Printer's Dimensions	22"(W) × 20-1/2"(D) × 16"(H) (561 × 521 × 409 mm)
Printer's Weight	61-3/4 lbs. (28kg) <Including Imaging Cartridge>
Printer's Option:	Second Paper Cassette Unit

* Specifications subject to change without notice.

1. Specifications

MS 6000 + MSP 2000 Printer

Type:	Microfilm Scanner Printer System
Printing Method:	Laser Electrostatic
Resolution:	400 dpi
Developing System:	Minolta Fine Micro-Toning (Fine-MT) System
Print Size:	8-1/2" × 11" (or A4)
Print Speed:	8 sheets per minute (8-1/2" × 11" or A4)
First Print Time:	19 seconds (8-1/2" × 11" or A4)
Warm-up Time:	Less than 20 seconds
Multiple Printing:	1-19 sheets (LED countdown identification)
Paper Supply:	Automatic Feeding System Multipurpose tray (150 sheets max.)
Power Consumption:	Less than 930W (Scanner: 350W, Printer: 580W)
Printer's Dimensions	15-1/2"(W) × 17-1/2"(D) × 13"(H) (394 × 446 × 328 mm)
Printer's Weight	17 lbs. (7.8kg) <Including Toner/Drum Cartridge>
Printer's Option:	Face-Up Tray

* Specifications subject to change without notice.

2. Initial Settings List



This system offers two types of settings: one is the user settings that are made by the user on the control panel and the other is the system settings that are made by the Minolta authorized dealer. Here is a list of factory settings for these two setting types.

User Settings	Initial Setting	Remark
Exposure mode	Auto	
Print image density	Center	
Print Format	Portrait	
Film type	Auto	
Auto Skew Correction	OFF	
Auto Masking	OFF	
Manual Masking	-	Enabled only when the Manual Frame Masking Kit (option) is mounted.
Centering/Fit	OFF	

- * When any of these functions has been changed and you want to store that new setting in the system's memory, press the Memory Input Key.

System Settings	Description	Selection	Initial Setting
Auto reset	Setting changes made to the control panel that are not used within 60 seconds of being input are automatically cancelled and the system reverts back to the original settings.	Enabled Disabled	√
Auto power save (PR mode only)	Turns the Printer's fuser OFF if the system is left idle for a specific period of time. * 200V units operate on a default 30 minute Auto Power Save setting.	Disabled 30 min. 60 min.	√
Auto Projection Lamp OFF	Turns the Scanner's Projection Lamp OFF if the system is left idle for a specified period of time.	Disabled 30 min. 60 min.	√
Fine mode contrast select	Applies the following functions as required: Contrast Emphasis: applied when film contains text that is poorly contrasted against its background making it difficult to read. Outline Emphasis: applied when film contains blurred black and white images.	Contrast Emphasis Outline Emphasis	√

2. Initial Settings List

System Settings	Description	Selection	Initial Setting
Auto Skew Correction Retain	Determines whether or not to retain the original (uncorrected) skew of a screen image after the print has been made.	Retained Not retained	√
Machine ID Printing (MSP 3000 printer only)	When two scanners are connected to one printer, this function leaves an identification marker on the print so that the scanner used for the job can be determined after printing. <div style="display: flex; justify-content: space-around; align-items: center;"> <div style="text-align: center;"> <p>Pattern 1</p>  <p>Paper</p> </div> <div style="text-align: center;"> <p>Pattern 2</p>  <p>Paper</p> </div> </div>	Disabled Pattern 1 Pattern 2	√
Cycle print mode (PR mode only)	This function automatically scans the next image following a preset period of time (the period can be set by an authorized dealer). Images are set by the user onto the Carrier Glass in between cycles.	Enabled Disabled	√
Paper Size of Paper Feeding Tray (MSP 3000 printer only)	Determines the desired paper size from the Paper Feeding Tray of the printer. It is possible to feed the following paper sizes and orientations into the printer: Letter (Lengthwise) Letter (Crosswise)	Lengthwise Crosswise	√
Contrast setting	To view subtle images with standard ranges of density clearly: Light (-1 - -7) To bring out the darker and lighter ranges of an image: Dark (+1 - +7)	Lighter Normal Darker	√

2. Initial Settings List

System Settings	Description	Selection	Initial Setting
The print function at the time of Toner Empty detection (PR mode only)	After a toner empty condition is detected, this function allows you to select either to stop printing or continue printing	Disable Print Enable Print	√
Auto Film Format Select print function (PR mode only)	The Auto Format Select Print Function is enable or disable through the control panel. This function is used for managing horizontal and vertical printing when Letter or A4 size paper is set crosswise/lengthwise into the paper feeding tray/paper feeding cassette.	Enable Disable	√
90 degree rotation setting	Enables the prism to rotate the screen image 90 degrees.	Enable Disable	√
Automatic paper source switching (MSP 3000 printer only)	Allows you to specify the paper source when Letter or A4 size paper is loaded in Lengthwise or Crosswise orientations into the both paper feeding tray and paper feeding cassette. Auto switching: Printing continues by automatically switching to the remaining paper source after paper in the specified paper source runs out. Disabling Auto Switching: A paper empty mode occurs and printing ceases after paper in the specified paper source runs out. The paper source must be refilled or the paper source must be switched by pressing the Output Selection Key in order to resume printing.	Auto switching Disabling Auto Switching	√

* To change any of the system settings described above, contact your Minolta authorized dealer.

3. System Care

The system should be cleaned on a daily basis for optimal operating conditions.

Cleaning the Scanner

Screen

- 1 With a damp cloth, clean and remove any dust or debris from the surface of the Screen.

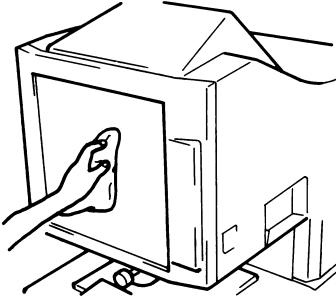

NOTE

NEVER use alcohol or any other solvent when cleaning to avoid causing damage to the Screen or erasing the frame size markers.

Outer Covers

- 1 Dust the exterior panels of the Scanner with a soft, dry cloth.

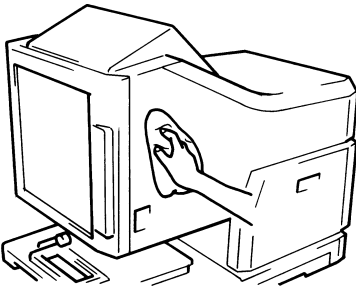

Carrier Glass (Option)

- 1 With a damp cloth, clean and remove any dust or debris from the surface of the Carrier Glass.

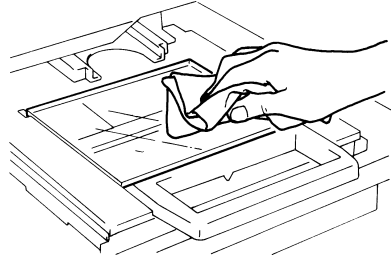

NOTE

Before cleaning the Carrier Glass, be sure to remove the Projection Lens from the Scanner.

- 2 To open the Carrier Glass, pull the handle of the Microfiche Holder. Following the same procedure described in Step 1, wipe the inner surfaces of the Carrier Glass.

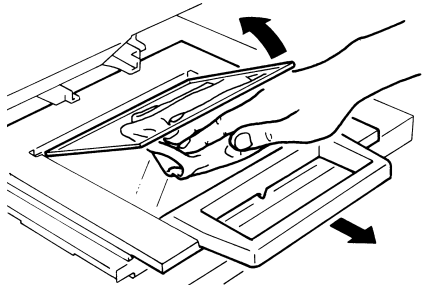

- 3 Dry and polish the glasses with a soft, dry cloth to prevent spotting or smearing.

Cleaning the MSP 3000 Printer

Clean the Printer at regular intervals.

NOTE

- *Before cleaning the Printer, turn OFF the power and unplug the cord from the power outlet.*
 - *Use a soft cloth and NEVER use abrasives or corrosive detergents.*
-

Exterior Panels

- I** Clean the exterior panels with a soft, dry cloth. A damp cloth and a mild home detergent can be used for heavier cleaning.

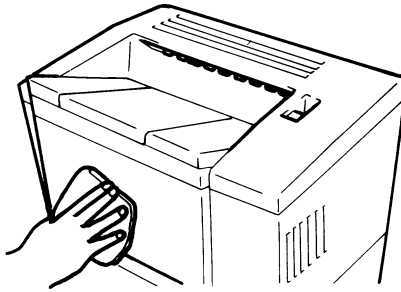

For Key Operator's Use

When you need to call for service, the Key Operator should be prepared to provide the following information to your Minolta authorized Dealer.

1. Your Company Name, Address, Telephone Number, Department Name, Floor Number, Machine Location, etc.
2. Model Name, Serial Number, Condition or System(s) Indication(s) on the Display, etc.

For your reference purpose.

Model Name	MS 6000	Serial No. _____
	Printer (MSP 3000)	Serial No. _____
	Printer (MSP 2000)	Serial No. _____
Attached Accessories		Serial No. _____
		Serial No. _____
		Serial No. _____
		Serial No. _____
		Serial No. _____
Installation Date		
Authorized Dealer's Name TEL. No. Address		



MINOLTA

Copyright
2001 MINOLTA CO., LTD

The information contained in this manual is subject to change without notice to incorporate improvements made on the product or products the manual covers.

MINOLTA CO., LTD.

Image Information Products Marketing Headquarters

3-13, 2-chome, Azuchi-machi, Chuo-ku, Osaka. 541-8556, Japan